



**QUICK MARINE LIGHTING**  
**MADE IN ITALY**

**LIGHTING**



QUICK MARINE LIGHTING IS  
THE LIGHTING EQUIPMENT LINE DESIGNED  
AND MANUFACTURED BY QUICK SRL.  
A QUALIFIED AND EXPERIENCED STAFF,  
AN ADVANCED TECHNOLOGICAL EQUIPMENT,  
AND A HIGH-TECH LAB AT YOUR DISPOSAL  
TO MAKE YOUR BOAT UNIQUE.

QUICK MARINE LIGHTING E' LA LINEA  
DI APPARECCHI PER L' ILLUMINAZIONE  
PROGETTATA E PRODOTTA DA QUICK SRL.  
PERSONALE ESPERTO E QUALIFICATO,  
ATTREZZATURE ALL'AVANGUARDIA  
E UN LABORATORIO TECNOLOGICAMENTE  
EVOLUTO SONO A TUA DISPOSIZIONE  
PER RENDERE LA TUA BARCA UNICA.



**THE FACTORY**

**QUICK NAUTICAL EQUIPMENT**

**QUICK MARINE LIGHTING**

**LED TECHNOLOGY & SOLUTIONS**

# QUICK, High Quality Nautical Equipment



Quick® s.r.l. successfully enters the nautical sector thanks to Michele Marzucco and Alfonso Peduto in 1992.

Already founders of the company PM, Marzucco and Peduto started their collaboration in 1983 selling and installing nautical instruments and accessories. It is from this experience that the idea of designing and building their own range of products originated and, with the acquisition of Quick® 18 years ago, became real.

Today the company distinguishes itself in the sector for a wide variety of items, and it is a guarantee of quality and professionalism both in Italy and in the over 50 countries in the world where it operates.

Quick® s.r.l. entra con successo nel settore nautico grazie a Michele Marzucco e Alfonso Peduto.

Già fondatori della società PM, Marzucco e Peduto iniziano la loro collaborazione nel 1983, con la vendita e l'installazione di accessori e strumenti nautici.

Da questa esperienza nasce l'idea di progettare e costruire una propria gamma di prodotti che si concretizza con l'acquisizione di Quick® 18 anni fa.

Oggi l'azienda italiana vanta una varietà di articoli marini senza paragoni ed è garanzia di qualità e professionalità sia sul territorio nazionale che negli oltre 50 paesi del mondo nei quali distribuisce.

# QUICK, High Quality Nautical Equipment



**Innovation, research and constant development of technology are the main strong points of Quick®.**

**The main lines of Quick® range** are as follows: windlasses, bow thrusters, water heaters, battery chargers, remote controls, electrical accessories and lights for internal and external applications with the **new division Quick Marine Lighting**.

The plant, located in Ravenna, occupies an area of 12,000 m<sup>2</sup> and includes 7 production departments, 3 research and development laboratories, product test benches and of course the offices including management, commercial department, purchasing and logistics.

**Firm with quality management  
System uni en ISO 9001.2008 Certified.**

**L'innovazione, la ricerca ed il continuo sviluppo delle tecnologie sono i principali punti di forza dell'azienda Quick®.**

**Le principali linee della gamma Quick®** sono rappresentate da salpa ancora, bow thruster, boiler, carica batterie, comandi remoti, accessori elettrici e luci da interni ed esterni con la nuova **divisione Quick Marine Lighting**.

Lo stabilimento, con sede a Ravenna, è distribuito su una superficie di 12.000 m<sup>2</sup> e comprende 7 reparti di produzione, 3 laboratori di ricerca e progettazione, le sale di collaudo e prova dei prodotti e naturalmente i diversi uffici che costituiscono la direzione, l'organizzazione commerciale, gli acquisti ed il settore logistica.

**Quick® è un'azienda certificata con  
il Sistema di qualità uni en ISO 9001.2008**

# QUICK Marine Lighting

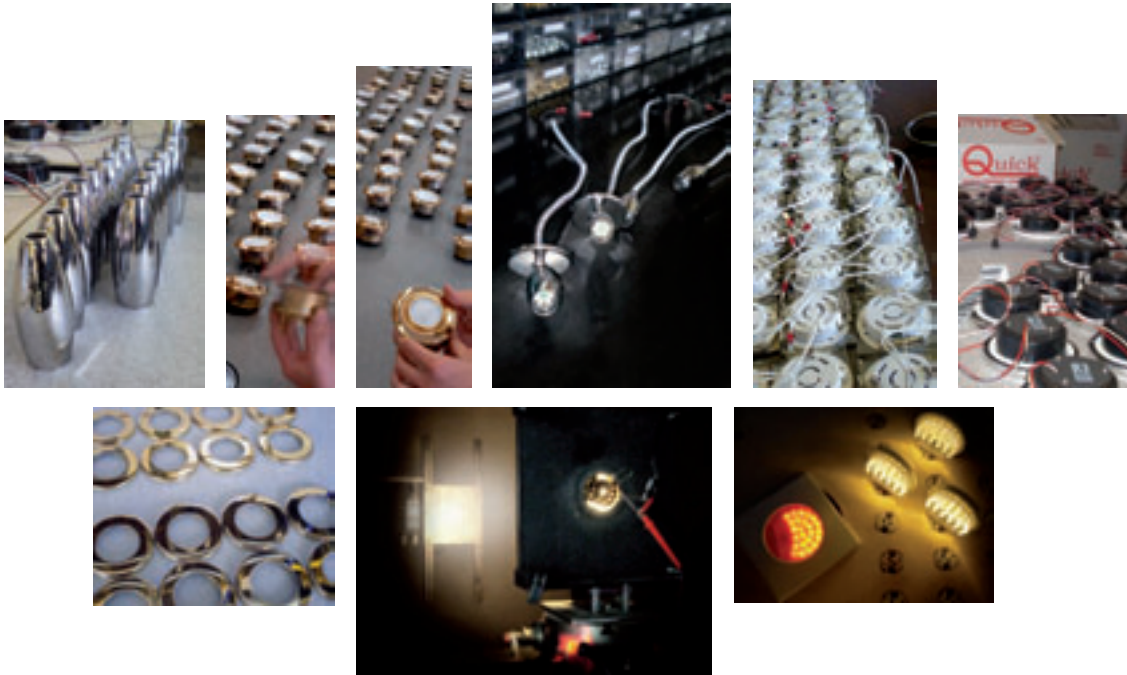

In 2007, a year of great growth and renovation, Quick® extends its plants to Ravenna and creates a new division: **Quick Marine Lighting**. The strategy is aimed at extending its target market toward the field of furnishings, with technically innovative lighting products.

The products included in the range are the result of a thorough search, aimed at developing innovative and high-quality lighting fixtures.

Most of the resources have been dedicated to the research and development of LED equipment for general lighting, with solutions which perfectly integrate conventional light sources.

Nel 2007, anno di grande crescita e rinnovamento, Quick® amplia gli stabilimenti a Ravenna e forma una nuova divisione: la **Quick Marine Lighting**. La strategia è indirizzata ad ampliare il proprio target di mercato verso il settore dei componenti di arredo, con prodotti illuminotecnici innovativi.

Le soluzioni presenti nella gamma sono il risultato di un'attenta ricerca mirata a sviluppare prodotti illuminotecnici innovativi e di elevata qualità'.

Gran parte delle risorse sono state dedicate alla creazione di apparecchiature a led per l'illuminazione generale, con soluzioni che integrano perfettamente le sorgenti di luce tradizionale.

# QUICK Marine Lighting LED Technology & Solutions

Discovered more than 40 years ago, LED technology has progressed to a level where it can be integrated into mainstream applications, and QML is leading the way.

**Quick Marine Lighting team** combined years of experience in LED work in industrial, domestic, and automotive with deep knowledge of the marine market requirements.

We designed LED light fixtures constantly searching for innovative solutions through cost-effective production processes.

**Quick Marine Lighting** is today capable of replacing all conventional lighting applications into LED, with realistic and practical solutions, solving problems that may occur during installation and maintenance of light on board.

Scoperta più di 40 anni fa la tecnologia LED è progredita ad un livello tale da poter essere integrata in applicazioni tradizionali, e QML segna il passo.

**Il team Quick Marine Lighting** mette insieme anni di esperienza nel mercato industriale, domestico e automobilistico dei LED ad una profonda conoscenza delle esigenze del mercato marino.

Progettiamo soluzioni innovative utilizzando metodi di produzione economicamente efficienti.

**Quick Marine Lighting** offre ai clienti del settore nautico la possibilità di trasformare a LED le applicazioni illuminotecniche tradizionali con soluzioni reali e pratiche, capaci di risolvere le difficoltà che si riscontrano nella scelta, nell'installazione e nella manutenzione della luce.





# THE PRODUCTS

**LED LIGHTING**

**HALOGEN LIGHTING**

**LAMPSHADES**

**ACCESSORIES**

# LED & POWER LED LIGHTING

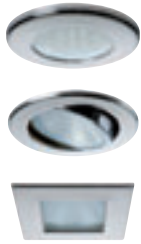

## RECESSED LED DOWNLIGHTS **1**

<b>NEW</b>   BRYAN	p. 54
<b>NEW</b>   CAMILLA	p. 48
CHIARA	p. 42
<b>NEW</b>   DEMETRA	p. 62
<b>NEW</b>   EDWIN	p. 52
<b>NEW</b>   JD	p. 50
<b>NEW</b>   JO	p. 18
KAI	p. 34
KOR	p. 36
<b>NEW</b>   KRISTINE	p. 58
<b>NEW</b>   LUCILLE	p. 22
MARINA	p. 56
<b>NEW</b>   MIRIAM	p. 30
NIKITA	p. 38
NK accessories	p. 40
<b>NEW</b>   OMAR	p. 28
<b>NEW</b>   SELENE	p. 32
SONIA	p. 44
<b>NEW</b>   TED	p. 24
<b>NEW</b>   TED S	p. 26
<b>NEW</b>   THEKLA	p. 46
<b>NEW</b>   VANESSA	p. 60
<b>NEW</b>   YOKO	p. 20



## LED SURFACE-MOUNT FIXTURES **2**

<b>NEW</b>   MINDY	p. 74
<b>NEW</b>   MINDY S	p. 76
<b>NEW</b>   OLIVER	p. 70
<b>NEW</b>   OLIVER S	p. 72
<b>NEW</b>   SANDY	p. 78
<b>NEW</b>   TIM	p. 66
<b>NEW</b>   TIM S	p. 68



## LED READING LIGHTS **3**

<b>NEW</b>   AUDREY	p. 88
CHLOE	p. 94
<b>NEW</b>   JOYCE LED	p. 84
MAGDA	p. 98
MAYA 30/60	p. 86
NICOLE	p. 82
PETRA	p. 96
SHARK 30/50	p. 90
YASMEEN	p. 82



## LED COURTESY LIGHTS **4**

<b>NEW</b>   GLADIS	p. 118
<b>NEW</b>   GRACE	p. 110
<b>NEW</b>   HARRIET	p. 108
<b>NEW</b>   HALLIE	p. 116
ILENIA	p. 114
IRENE	p. 106
PATRICIA	p. 104
<b>NEW</b>   TESS	p. 112
TINA	p. 102



## LED LIGHT BARS **5**

<b>NEW</b>   MODULAR 2D	p. 124
<b>NEW</b>   MODULAR 3D	p. 126
<b>NEW</b>   SYRIA	p. 122



## LED INDIRECT LIGHTS **6**

STRIP LED	p. 130
<b>NEW</b>   STRIP LED HP	p. 132



## LED UTILITY LIGHTS **7**

KIRK	p. 138
<b>NEW</b>   SECRET LIGHT	p. 136



## LED UNDERWATER LIGHTS **8**

XYPER 18	p. 142
----------	--------



## LED BULBS **9**

ZELIG BE	p. 146
ZELIG SE	p. 148



## HALOGEN LIGHTING



### RECESSED HALOGEN DOWNLIGHTS

10

ALEX	p. 166
ANDREAS	p. 174
BERNARD	p. 188
BORIS	p. 172
CARMEN	p. 184
EDGAR	p. 186
ELISABETH	p. 176
GIULIA	p. 178
LARA	p. 192
LAWRENCE	p. 168
LISA	p. 190
LUCREZIA	p. 170
MINA	p. 162
OLAF	p. 160
SABINE	p. 164
SILVIA	p. 180
TEO	p. 156
TEO S	p. 158
TOSCA	p. 182



### HALOGEN SURFACE-MOUNT FIXTURES

11

<b>NEW</b>   MILLY	p. 204
<b>NEW</b>   MILLY S	p. 206
OSCAR	p. 200
OSCAR S	p. 202
<b>NEW</b>   SALLY	p. 208
TOM	p. 196
TOM S	p. 198



### HALOGEN READING LIGHTS

12

<b>NEW</b>   JOYCE	p. 212
--------------------	--------

### HALOGEN BULBS

13

XENON G4	p. 215
----------	--------

## LAMPSHADES



### WALL LIGHTS

14

<b>NEW</b>   DOMINIQUE	p. 240
<b>NEW</b>   DOMITILLA	p. 238
<b>NEW</b>   DOMIZIANA	p. 236
<b>NEW</b>   IOLANDA	p. 228
<b>NEW</b>   ISABELLA	p. 222
<b>NEW</b>   SHARON 10	p. 230
SHARON 15	p. 232
<b>NEW</b>   SHARON 20	p. 234
SHEILA	p. 220



### TABLE LIGHTS

15

<b>NEW</b>   DENISE	p. 252
<b>NEW</b>   ISOTTA	p. 250
<b>NEW</b>   SARAH	p. 254

## ACCESSORIES



### DIMMERS

16

LDM1	p. 259
ZDIM100	p. 260
HDIM300 MASTER	p. 261
HDIM300 SLAVE	p. 261



### POWER SUPPLIERS AC-DC

17

PS 45 W	p. 263
PS 60 W	p. 263
PS 240 W	p. 263

### BULBS CHART

p. 264





**LED LIGHTING**

- 1 RECESSED LED DOWNLIGHTS
- 2 LED SURFACE-MOUNT FIXTURES
- 3 LED READING LIGHTS
- 4 LED COURTESY LIGHTS
- 5 LED LIGHT BARS
- 6 LED INDIRECT LIGHTS
- 7 LED UTILITY LIGHTS
- 8 LED UNDERWATER LIGHTS
- 9 LED BULBS

**LED LIGHTING**

# RECESSED LED DOWNLIGHTS

FOR EXTERIOR AND INTERIOR APPLICATIONS

RECESSED DOWNLIGHTS  
FOR EXTERIOR AND INTERIOR APPLICATIONS.  
TRIM RINGS IN AISI 316 STAINLESS STEEL.  
LED AND POWER LED LIGHT SOURCE.

FARETTI AD INCASSO PER ESTERNI ED INTERNI.  
CORNICI IN ACCIAIO INOX AISI 316.  
SORGENTE DI LUCE A LED E POWER LED.

MODELS IN ALPHABETICAL ORDER

<b>NEW</b>   BRYAN	p. 54
<b>NEW</b>   CAMILLA CHIARA	p. 48 p. 42
<b>NEW</b>   DEMETRA	p. 62
<b>NEW</b>   EDWIN	p. 52
<b>NEW</b>   JD	p. 50
<b>NEW</b>   JO KAI KOR	p. 18 p. 34 p. 36
<b>NEW</b>   KRISTINE	p. 58
<b>NEW</b>   LUCILLE MARINA	p. 22 p. 56
<b>NEW</b>   MIRIAM NIKITA NK accessories	p. 30 p. 38 p. 40
<b>NEW</b>   OMAR	p. 28
<b>NEW</b>   SELENE SONIA	p. 32 p. 44
<b>NEW</b>   TED	p. 24
<b>NEW</b>   TED S	p. 26
<b>NEW</b>   THEKLA	p. 46
<b>NEW</b>   VANESSA	p. 60
<b>NEW</b>   YOKO	p. 20

**RECESSED LED DOWNLIGHTS  
FOR EXTERIOR AND INTERIOR APPLICATIONS  
FARETTI LED AD INCASSO PER ESTERNI ED INTERNI**

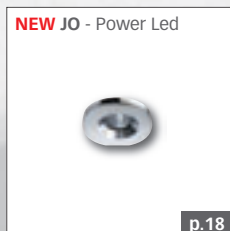

IP65 - Ø 42 - Recess 19

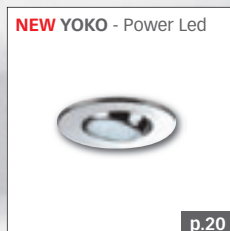

IP40 - Ø 65 / Recess 31

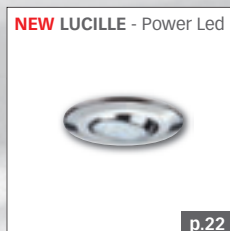

IP40 - Ø 65 / Recess 29

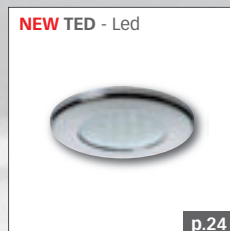

IP40/65 - Ø 72 / Recess 16/13

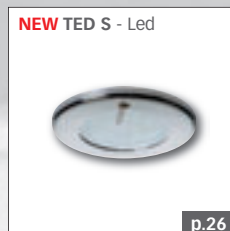

IP40 - Ø 72 / Recess 17

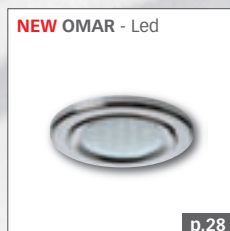

IP40/65 - Ø 72 / Recess 16/13

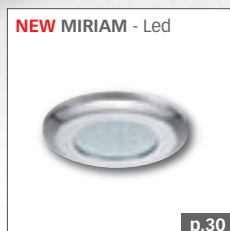

IP40/65 - Ø 77 / Recess 16/14

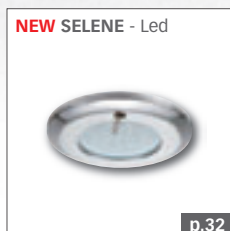

IP40 - Ø 77 / Recess 16

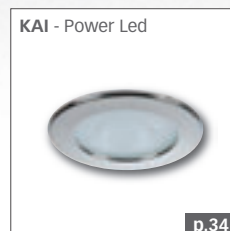

IP65 - Ø 80 / Recess 33

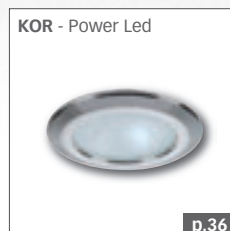

IP65 - Ø 80 / Recess 33



IP40 - Ø 85 / Recess 35



Nikita downlight Frames



IP65 - Ø 87 / Recess 28



IP65 - Ø 105 / Recess 33



IP65 - Ø 155 / Recess 25

IP40 = for interior applications only  
IP40 = solo per interni

IP65 = for interior and exterior applications  
IP65 = per interni ed esterni

Dimensions of diameter/maximum trim ring side length and recess are listed in mm  
Le dimensioni del diametro/lato max cornice e del recesso sono indicati in mm

**NEW Camilla** - Led

p.48

**IP65** - Ø 155 / Recess 25**NEW JD** - Power Led

p.50

**IP65** - Side 36 / Recess 19**NEW EDWIN** - Led

p.52

**IP40/65** - Side 72 / Recess 16/13**NEW BRYAN** - Led

p.54

**IP40/65** - Side 72 / Recess 16/13**MARINA** - Power Led

p.56

**IP65** - Side 72 / Recess 34**NEW KRISTINE** - Power Led

p.58

**IP40** - Side 113 / Recess 59**NEW VANESSA** - Power Led

p.60

**IP40** - Side 113 / Recess 59**NEW DEMETRA** - Power Led

p.62

**IP65** - Side 112 / Recess 54

IP40 = for interior applications only  
IP40 = solo per interni

IP65 = for interior and exterior applications  
IP65 = per interni ed esterni

Dimensions of diameter/maximum trim ring side length and recess are listed in mm  
Le dimensioni del diametro/lato max cornice e del recesso sono indicati in mm



Voltage system / Sistema	12 V / 24 V
Light source / Sorgente	POWER LED
Operating voltage / Voltaggio	8 - 30 Vdc
Power consumption / Potenza consumo	1,5 W
Ampère consumption / Consumo Ampère	0,12 A @ 12 V / 0,06 A @ 24 V
LED protection / Protezione LED	Spike protected / Picchi di voltaggio $\pm$ 500 V
Polarity sensitive / Polarità	No

Beam 25° / Angolo 25°

Distance / Distanza

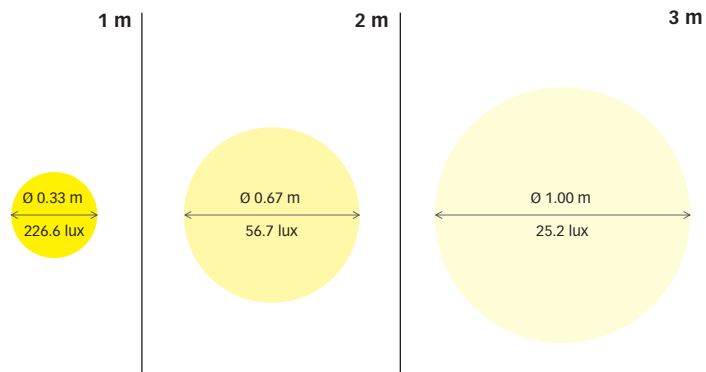
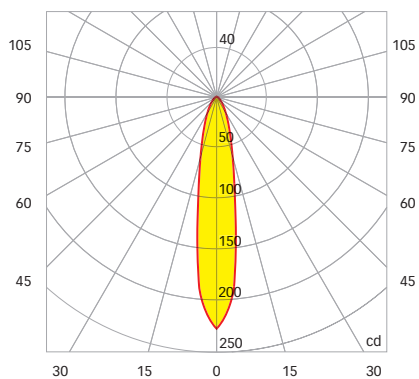

Certifications / Certificazioni



**NEW** | JO - POWER LED

**RECESSED LED DOWNLIGHTS  
FARETTI LED AD INCASSO**

For exterior and interior applications / Per esterni ed interni



- Light color / Colore Luce**
- Daylight / Bianco Naturale
  - Warm White / Bianco Caldo
- Material / Materiale**
- AISI 316 Stainless Steel / Acciaio Inox**
- Finishes / Finiture\***
- Mirror polished / Inox lucido
  - Satin / Satinato
  - White 9010 / Bianco 9010

**Dimensions / Dimensioni**

- 19 mm** (3/4 in)
- 42 mm** (1 41/64 in)
- 25 mm** (63/64 in)

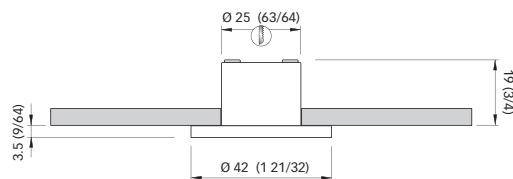

\*Other finishes available upon request / Altre finiture su richiesta

Dimensions in mm (inch)



## NEW | YOKO - POWER LED



<b>Voltage system / Sistema</b>	<b>12 V / 24 V</b>
<b>Light source / Sorgente</b>	<b>POWER LED</b>
Operating voltage / Voltaggio	10 - 30 Vdc
<b>Power consumption / Potenza consumo</b>	<b>1,5 W</b>
Ampère consumption / Consumo Ampère	0,12 A @ 12 V / 0,06 A @ 24 V
LED protection / Protezione LED	Spike protected / Picchi di voltaggio $\pm$ 500 V
Polarity sensitive / Polarità	No
Dimming / Dimmerazione	Yes, with ZDIM100 / Sì, con ZDIM100

Beam 30° / Angolo 30°

Distance / Distanza

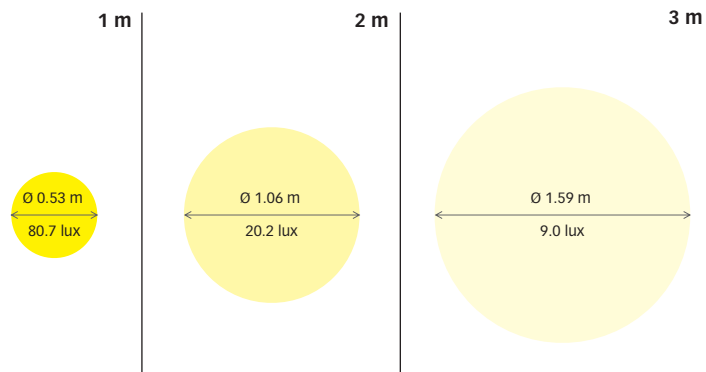
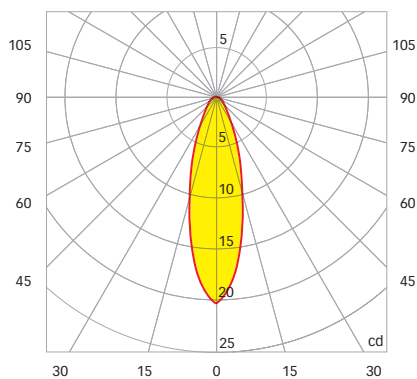

Certifications / Certificazioni



**NEW** | YOKO - POWER LED

## RECESSED LED DOWNLIGHTS FARETTI LED AD INCASSO

1

Per interni / For interiors

Adjustable  
DOWNLIGHT

IP40



65

31



- Light color / Colore Luce**
- Daylight / Bianco Naturale
  - Warm White / Bianco Caldo
- Material / Materiale** AISI 316 Stainless Steel / Acciaio Inox
- Finishes / Finiture\***
- Mirror polished / Inox lucido
  - Satin / Satinato
  - White 9010 / Bianco 9010

### Dimensions / Dimensioni

-  31 mm (1 7/32 in)
-  65 mm (2 9/16 in)
-  52 mm (2 3/64 in)

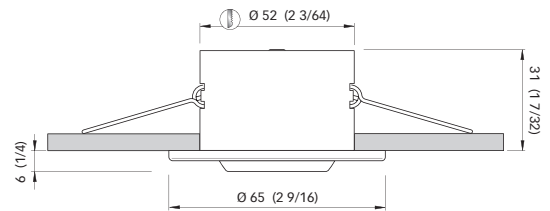

\*Other finishes available upon request / Altre finiture su richiesta

Dimensions in mm (inch)

QUICK MARINE LIGHTING



**NEW** | LUCILLE - POWER LED

Voltage system / Sistema	12 V / 24 V
Light source / Sorgente	POWER LED
Operating voltage / Voltaggio	10 - 30 Vdc
Power consumption / Potenza consumo	1,5 W
Ampère consumption / Consumo Ampère	0,12 A @ 12 V / 0,06 A @ 24 V
LED protection / Protezione LED	Spike protected / Picchi di voltaggio $\pm$ 500 V
Polarity sensitive / Polarità	No
Dimming / Dimmerazione	Yes, with ZDIM100 / Sì, con ZDIM100

Beam 30° / Angolo 30°

Distance / Distanza

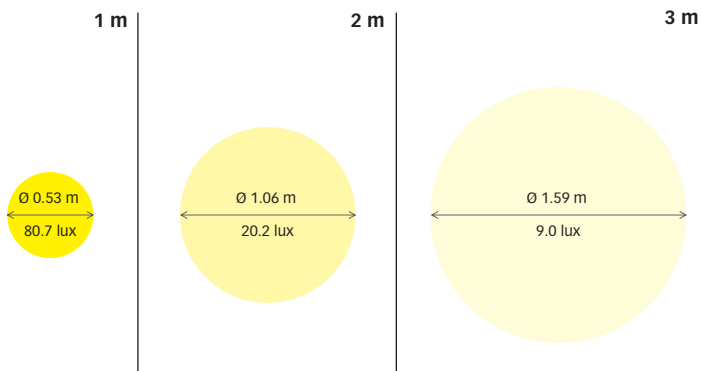
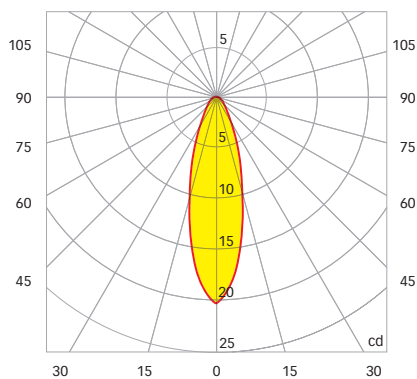

Certifications / Certificazioni



# NEW | LUCILLE - POWER LED

# RECESSED LED DOWNLIGHTS FARETTI LED AD INCASSO

Per interni / For interiors

Adjustable  
DOWNLIGHT

IP40



65

29



- Light color / Colore Luce**
- Daylight / Bianco Naturale
  - Warm White / Bianco Caldo
- Material / Materiale** AISI 316 Stainless Steel / Acciaio Inox
- Finishes / Finiture\***
- Mirror polished / Inox lucido
  - Satin / Satinato
  - White 9010 / Bianco 9010

## Dimensions / Dimensioni

-  29 mm (1 1/8 in)
-  65 mm (2 9/16 in)
-  52 mm (2 3/64 in)

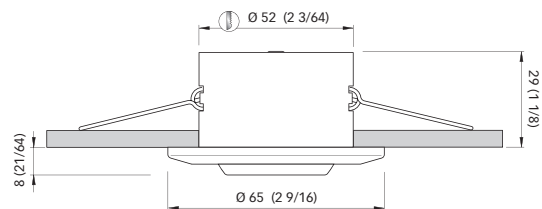

\*Other finishes available upon request / Altre finiture su richiesta

Dimensions in mm (inch)



**NEW | TED - LED****HIGHER LUMINOSITY, LOWER CONSUMPTION**

The new LED downlights are equipped with a multi-voltage (12-24 V) integrated LED board. They are also available in the IP65 version for outdoor applications.

**MAGGIORE LUMINOSITA', MINORE CONSUMO**

I nuovi faretti LED sono dotati di scheda LED integrata multivoltaggio (12/24 V). Sono disponibili anche nella versione per esterno IP65.

Voltage system / Sistema	12 V / 24 V
Light source / Sorgente	22 LED - High Luminosity / Alta Luminosità
Operating voltage / Voltaggio	8 - 30 Vdc
Power consumption / Potenza consumo	2 W
Ampère consumption / Consumo Ampère	0,15 A @ 12 V / 0,08 A @ 24 V
LED protection / Protezione LED	Against inversion of polarity / Contro l'inversione di polarità
	Spike protected / Picchi di voltaggio $\pm$ 500 V
Polarity sensitive / Polarità	Si/Yes
Dimming / Dimmerazione	With ZDIM100 / Con ZDIM100

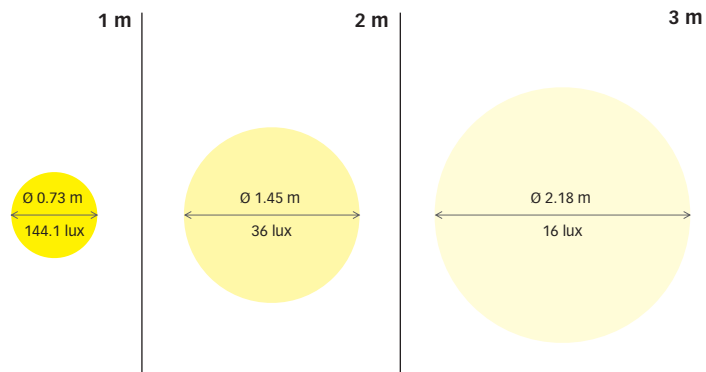
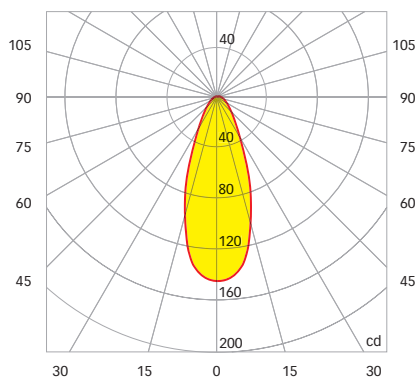
**Beam 40° / Angolo 40°****Distance / Distanza****Certifications / Certificazioni**

For exterior and interior applications / Per esterni ed interni



- Light color / Colore Luce**
- Daylight / Bianco Naturale
  - Warm White / Bianco Caldo
  - Red / Rosso
  - Bicolor - Warm white and blue  
Bicolore - Bianco caldo e blu

- Material / Materiale**     **AISI 316 Stainless Steel / Acciaio Inox**
- Finishes / Finiture**
- Mirror polished / Inox lucido
  - Satin / Satinato
  - White 9010 / Bianco 9010
  - Gold / Oro PVD
  - Bronze / Bronzo PVD
  - Black Nickel / Nichel Nero PVD

**TED IP40 with spring installation**  
**TED IP40 con fissaggio a molle**



**Dimensions / Dimensioni**

- 16 mm (5/8 in)**
- 72 mm (2 53/64 in)**
- 54 mm (2 1/8 in)**

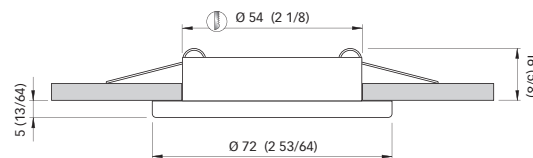

**TED IP65 with screw base installation**  
**TED IP65 con fissaggio a viti**



**Dimensions / Dimensioni**

- 13 mm (33/64 in)**
- 72 mm (2 53/64 in)**
- 54 mm (2 1/8 in)**

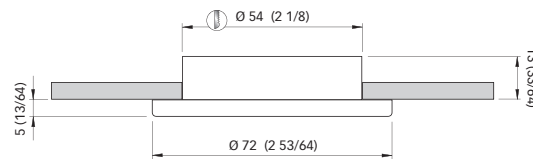

Dimensions in mm (inch)



**NEW | TED S - LED****HIGHER LUMINOSITY, LOWER CONSUMPTION**

The new LED downlights are equipped with a multi-voltage (12-24 V) integrated LED board.

**MAGGIORE LUMINOSITA', MINORE CONSUMO**

I nuovi faretti LED sono dotati di scheda LED integrata multivoltaggio (12/24 V).

Voltage system / Sistema	12 V / 24 V
Light source / Sorgente	22 LED - High Luminosity / Alta Luminosità
Operating voltage / Voltaggio	8 - 30 Vdc
Power consumption / Potenza consumo	2 W
Ampère consumption / Consumo Ampère	0,15 A @ 12 V / 0,08 A @ 24 V
LED protection / Protezione LED	Against inversion of polarity / Contro l'inversione di polarità
	Spike protected / Picchi di voltaggio $\pm$ 500 V
Polarity sensitive / Polarità	Si/Yes
Dimming / Dimmerazione	Yes, with ZDIM100 / Si, con ZDIM100

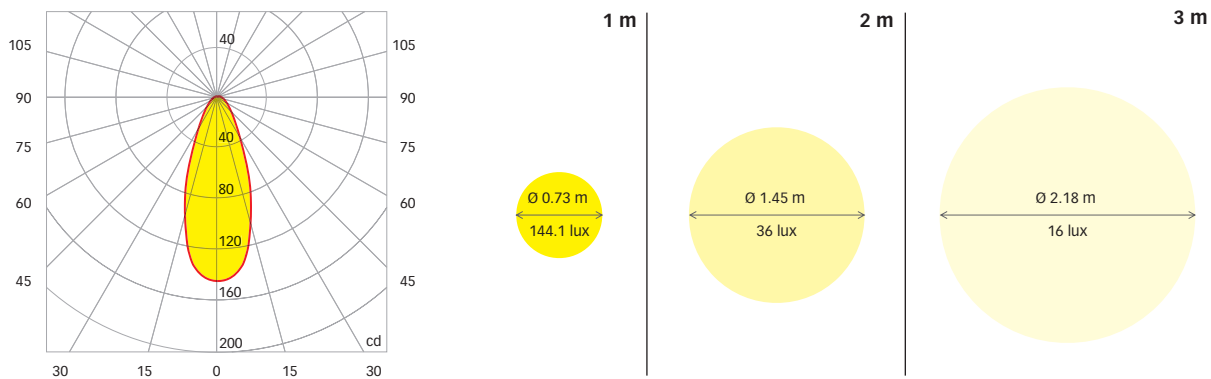
**Beam 40° / Angolo 40°****Distance / Distanza****Certifications / Certificazioni**

**NEW** | TED S - LED

## RECESSED LED DOWNLIGHTS FARETTI LED AD INCASSO

1

Per interni / For interiors

IP40 72 17



With switch  
Con interruttore

**Light color / Colore Luce**

- Daylight / Bianco Naturale
- Warm White / Bianco Caldo
- Red / Rosso

**Material / Materiale** AISI 316 Stainless Steel / Acciaio Inox

**Finishes / Finiture\***

- Mirror polished / Inox lucido
- Satin / Satinato
- White 9010 / Bianco 9010

IP40 with spring installation  
IP40 con fissaggio a molle

**Dimensions / Dimensioni**

 17 mm (43/64 in)

 72 mm (2 53/64 in)

 54 mm (2 1/8 in)

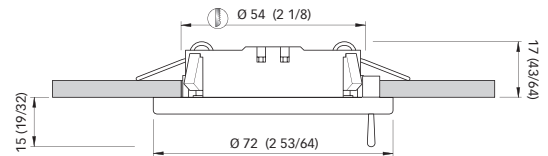

\*Other finishes available upon request / Altre finiture su richiesta

Dimensions in mm (inch)

QUICK MARINE LIGHTING



**NEW | OMAR - LED****HIGHER LUMINOSITY, LOWER CONSUMPTION**

The new LED downlights are equipped with a multi-voltage (12-24 V) integrated LED board. They are also available in the IP65 version for outdoor applications.

**MAGGIORE LUMINOSITA', MINORE CONSUMO**

I nuovi faretti LED sono dotati di scheda LED integrata multivoltaggio (12/24 V). Sono disponibili anche nella versione per esterno IP65.

Voltage system / Sistema	12 V / 24 V
Light source / Sorgente	22 LED - High Luminosity / Alta Luminosità
Operating voltage / Voltaggio	8 - 30 Vdc
Power consumption / Potenza consumo	2 W
Ampère consumption / Consumo Ampère	0,15 A @ 12 V / 0,08 A @ 24 V
LED protection / Protezione LED	Against inversion of polarity / Contro l'inversione di polarità
	Spike protected / Picchi di voltaggio $\pm$ 500 V
Polarity sensitive / Polarità	Si/Yes
Dimming / Dimmerazione	Yes, with ZDIM100 / Si, con ZDIM100

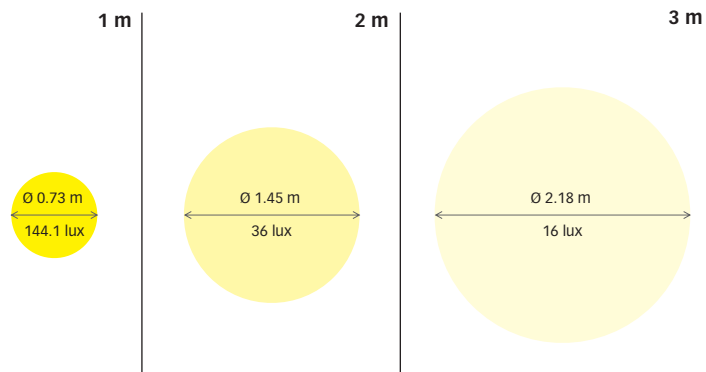
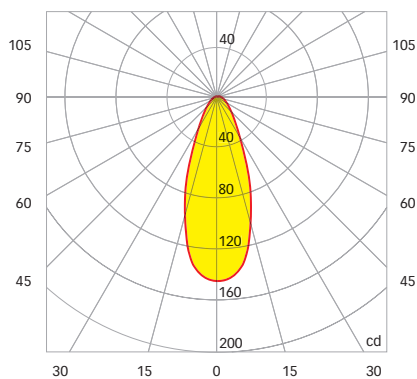
**Beam 40° / Angolo 40°****Distance / Distanza****Certifications / Certificazioni**

For exterior and interior applications / Per esterni ed interni



- Light color / Colore Luce**
- Daylight / Bianco Naturale
  - Warm White / Bianco Caldo
  - Red / Rosso
  - Bicolor - Warm white and blue  
Bicolore - Bianco caldo e blu

**Material / Materiale** AISI 316 Stainless Steel / Acciaio Inox

- Finishes / Finiture\***
- Mirror polished / Inox lucido
  - Satin / Satinato
  - White 9010 / Bianco 9010

\*Other finishes available upon request / Altre finiture su richiesta

**OMAR IP40 with spring installation  
OMAR IP40 con fissaggio a molle**

**IP40 72 16**

**Dimensions / Dimensioni**

 **16 mm (5/8 in)**

 **72 mm (2 53/64 in)**

 **54 mm (2 1/8 in)**

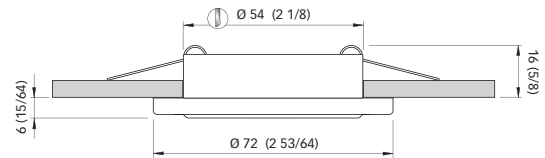

**OMAR IP65 with screw base installation  
OMAR IP65 con fissaggio a viti**

**IP65 72 13**

**Dimensions / Dimensioni**

 **13 mm (33/64 in)**

 **72 mm (2 53/64 in)**

 **54 mm (2 1/8 in)**

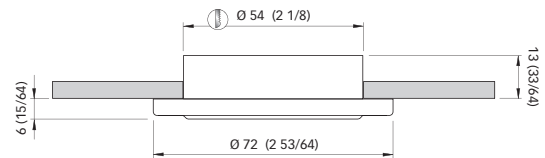

Dimensions in mm (inch)

**NEW | MIRIAM - LED****HIGHER LUMINOSITY, LOWER CONSUMPTION**

The new LED downlights are equipped with a multi-voltage (12-24 V) integrated LED board.

**They are available in the IP65 version for outdoor applications.**

**MAGGIORE LUMINOSITA', MINORE CONSUMO**

I nuovi faretto LED sono dotati di scheda LED integrata multivoltaggio (12/24 V).

**Disponibili nella versione per esterno IP65.**

Voltage system / Sistema	12 V / 24 V
Light source / Sorgente	22 LED - High Luminosity / Alta Luminosità
Operating voltage / Voltaggio	8 - 30 Vdc
Power consumption / Potenza consumo	2 W
Ampère consumption / Consumo Ampère	0,15 A @ 12 V / 0,08 A @ 24 V
LED protection / Protezione LED	Against inversion of polarity / Contro l'inversione di polarità
	Spike protected / Picchi di voltaggio $\pm$ 500 V
Polarity sensitive / Polarità	Si/Yes
Dimming / Dimmerazione	Yes, with ZDIM100 / Si, con ZDIM100

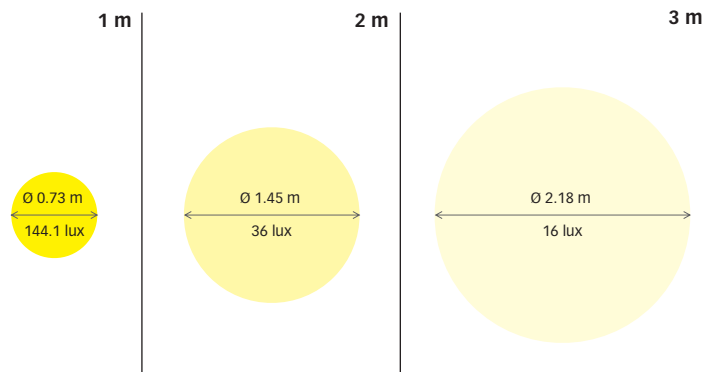
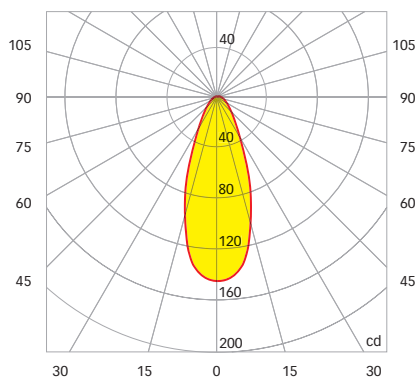
**Beam 40° / Angolo 40°****Distance / Distanza****Certifications / Certificazioni**

QUICK MARINE LIGHTING



# NEW | MIRIAM - LED

# RECESSED LED DOWNLIGHTS FARETTI LED AD INCASSO

For exterior and interior applications / Per esterni ed interni



- Light color / Colore Luce**
- Daylight / Bianco Naturale
  - Warm White / Bianco Caldo
  - Red / Rosso
  - Bicolor - Warm white and blue  
Bicolore - Bianco caldo e blu

**Material / Materiale** AISI 316 Stainless Steel / Acciaio Inox

- Finishes / Finiture\***
- Mirror polished / Inox lucido
  - Satin / Satinato
  - White 9010 / Bianco 9010

\*Other finishes available upon request / Altre finiture su richiesta

**MIRIAM IP40 with spring installation**  
**MIRIAM IP40 con fissaggio a molle**



**Dimensions / Dimensioni**

- 16 mm (5/8 in)**
- 77 mm (3 in)**
- 55 mm (2 7/32 in)**

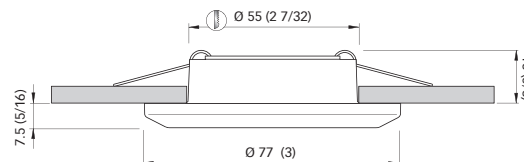

**MIRIAM IP65 with screw base installation**  
**MIRIAM IP65 con fissaggio a viti**



**Dimensions / Dimensioni**

- 14 mm (35/64 in)**
- 77 mm (3 in)**
- 55 mm (2 7/32 in)**

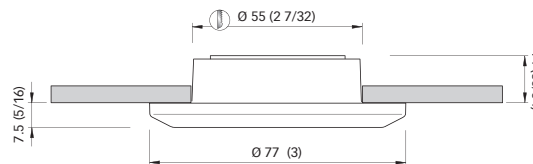

Dimensions in mm (inch)



**NEW | SELENE - LED****HIGHER LUMINOSITY, LOWER CONSUMPTION**

The new LED downlights are equipped with a multi-voltage (12-24 V) integrated LED board.

**MAGGIORE LUMINOSITA', MINORE CONSUMO**

I nuovi faretto **LED** sono dotati di scheda LED integrata multivoltaggio (12/24 V).

Voltage system / Sistema	12 V / 24 V
Light source / Sorgente	22 LED - High Luminosity / Alta Luminosità
Operating voltage / Voltaggio	8 - 30 Vdc
Power consumption / Potenza consumo	2 W
Ampère consumption / Consumo Ampère	0,15 A @ 12 V / 0,08 A @ 24 V
LED protection / Protezione LED	Against inversion of polarity / Contro l'inversione di polarità
	Spike protected / Picchi di voltaggio $\pm$ 500 V
Polarity sensitive / Polarità	Si/Yes
Dimming / Dimmerazione	Yes, with ZDIM100 / Si, con ZDIM100

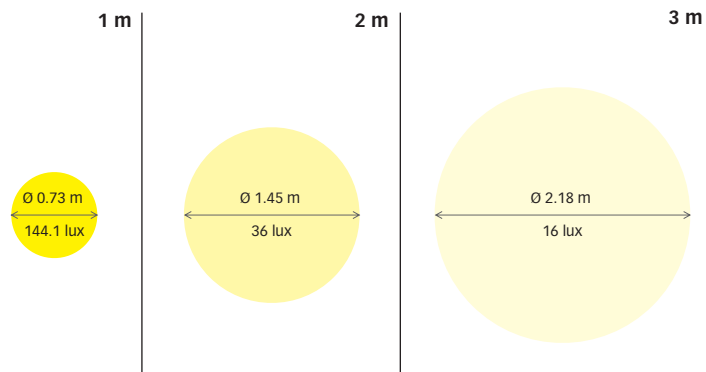
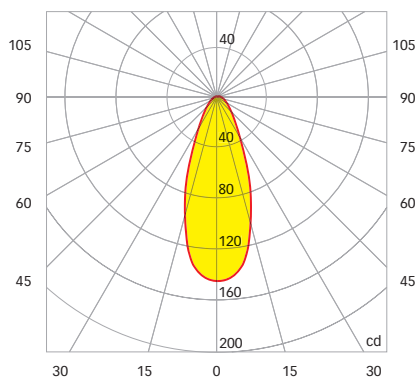
**Beam 40° / Angolo 40°****Distance / Distanza****Certifications / Certificazioni**

# NEW | SELENE - LED

# RECESSED LED DOWNLIGHTS FARETTI LED AD INCASSO

For interiors / Per interni



With switch  
Con interruttore

- Light color / Colore Luce**
- Daylight / Bianco Naturale
  - Warm White / Bianco Caldo
  - Red / Rosso
- Material / Materiale**      **AISI 316 Stainless Steel / Acciaio Inox**
- Finishes / Finiture\***
- Mirror polished / Inox lucido
  - Satin / Satinato
  - White 9010 / Bianco 9010

**SELENE IP40 with spring installation**  
**SELENE IP40 con fissaggio a molle**

### Dimensions / Dimensioni

 16 mm (5/8 in)

 77 mm (3 in)

 57 mm (2 1/4 in)

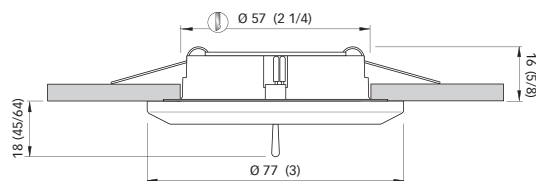

Dimensions in mm (inch)

\*Other finishes available upon request / Altre finiture su richiesta



## KAI - POWER LED



<b>Voltage system / Sistema</b>	<b>12 V / 24 V</b>
<b>Light source / Sorgente</b>	<b>POWER LED</b>
Operating voltage / Voltaggio	10 - 30 Vdc
<b>Power consumption / Potenza consumo</b>	<b>4 W</b>
Ampère consumption / Consumo Ampère	0,3 A @ 12 V / 0,16 A @ 24 V
LED protection / Protezione LED	Against inversion of polarity / Contro l'inversione di polarità
	Spike protected / Picchi di voltaggio $\pm$ 500 V
Polarity sensitive / Polarità	Yes / Sì
Dimming / Dimmerazione	Yes, with LDM1 / Sì, con LDM1

Beam 50° / Angolo 50°

Distance / Distanza

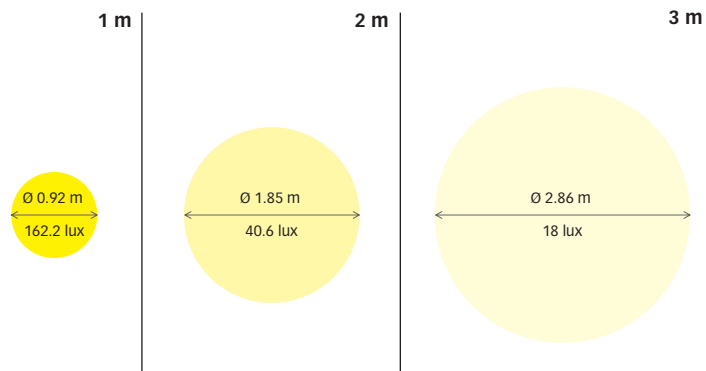
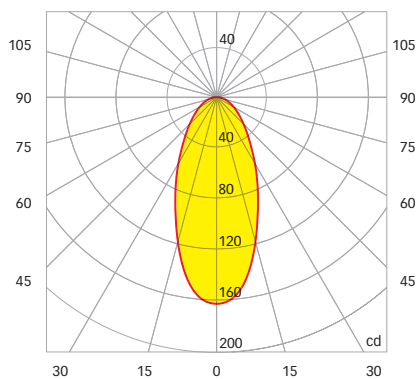

Certifications / Certificazioni



# KAI - POWER LED

# RECESSED LED DOWNLIGHTS FARETTI LED AD INCASSO

For exterior and interior applications / Per esterni ed interni



1



- Light color / Colore Luce**
- Daylight / Bianco Naturale
  - Warm White / Bianco Caldo
- Material / Materiale**      **AISI 316 Stainless Steel / Acciaio Inox**
- Finishes / Finiture\***
- Mirror polished / Inox lucido
  - Satin / Satinato
  - White 9010 / Bianco 9010

## Dimensions / Dimensioni

- 33 mm (1 9/32 in)**
- 80 mm (3 5/32 in)**
- 66 mm (2 19/32 in)**

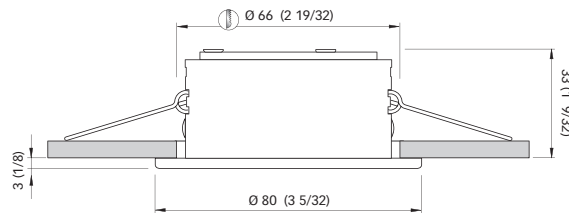

Dimensions in mm (inch)

\*Other finishes available upon request / Altre finiture su richiesta



## KOR - POWER LED



<b>Voltage system / Sistema</b>	<b>12 V / 24 V</b>
<b>Light source / Sorgente</b>	<b>POWER LED</b>
Operating voltage / Voltaggio	10 - 30 Vdc
<b>Power consumption / Potenza consumo</b>	<b>4 W</b>
Ampère consumption / Consumo Ampère	0,3 A @ 12 V / 0,16 A @ 24 V
LED protection / Protezione LED	Against inversion of polarity / Contro l'inversione di polarità
	Spike protected / Picchi di voltaggio $\pm$ 500 V
Polarity sensitive / Polarità	Yes / Sì
Dimming / Dimmerazione	Yes, with LDM1 / Sì, con LDM1

**Beam 50° / Angolo 50°**

**Distance / Distanza**

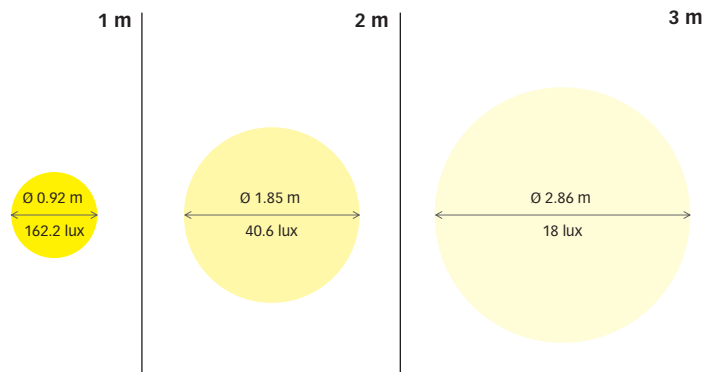
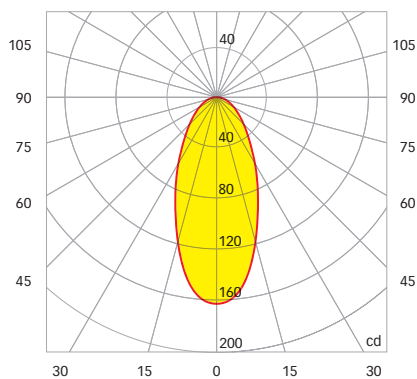

**Certifications / Certificazioni**



# KOR - POWER LED

# RECESSED LED DOWNLIGHTS FARETTI LED AD INCASSO

For exterior and interior applications / Per esterni ed interni



- Light color / Colore Luce**
- Daylight / Bianco Naturale
  - Warm White / Bianco Caldo
- Material / Materiale**      **AISI 316 Stainless Steel / Acciaio Inox**
- Finishes / Finiture\***
- Mirror polished / Inox lucido
  - Satin / Satinato
  - White 9010 / Bianco 9010

### Dimensions / Dimensioni

- 33 mm (1 9/32 in)**
- 80 mm (3 5/32 in)**
- 66 mm (2 19/32 in)**

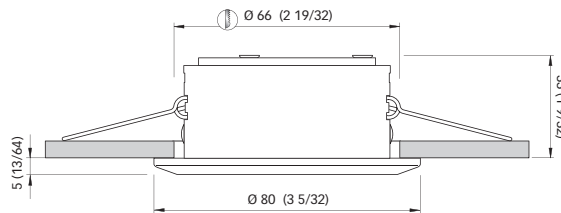

\*Other finishes available upon request / Altre finiture su richiesta

Dimensions in mm (inch)



## NIKITA - POWER LED



<b>Voltage system / Sistema</b>	<b>12 V / 24 V</b>
<b>Light source / Sorgente</b>	<b>POWER LED</b>
Operating voltage / Voltaggio	10 - 30 Vdc
<b>Power consumption / Potenza consumo</b>	<b>4 W</b>
Ampère consumption / Consumo Ampère	0,3 A @ 12 V / 0,16 A @ 24 V
LED protection / Protezione LED	Against inversion of polarity / Contro l'inversione di polarità
	Spike protected / Picchi di voltaggio $\pm$ 500 V
Polarity sensitive / Polarità	Yes / Sì
Dimming / Dimmerazione	Yes, with LDM1 / Sì, con LDM1

**Beam 50° / Angolo 50°**

**Distance / Distanza**

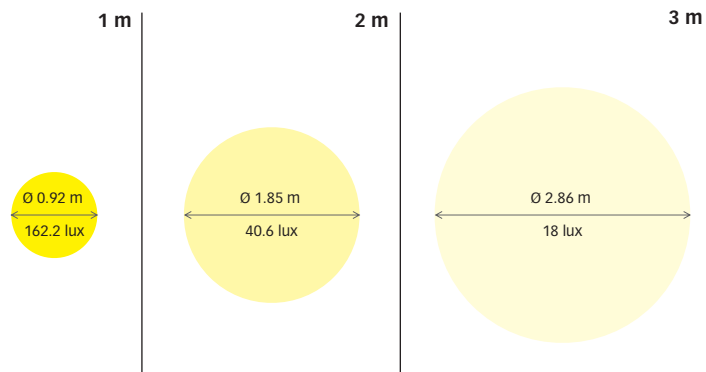
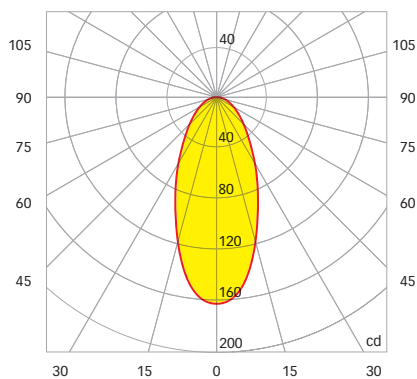

**Certifications / Certificazioni**



# NIKITA - POWER LED

# RECESSED LED DOWNLIGHTS FARETTI LED AD INCASSO

For interiors / Per interni

Adjustable  
DOWNLIGHT

IP40



85

35



- Light color / Colore Luce**
- Daylight / Bianco Naturale
  - Warm White / Bianco Caldo
- Material / Materiale**
- AISI 316 Stainless Steel / Acciaio Inox**
- Finishes / Finiture\***
- Mirror polished / Inox lucido
  - Satin / Satinato
  - White 9010 / Bianco 9010

## Dimensions / Dimensioni

-  **35 mm** (1 3/8 in)
-  **85 mm** (3 11/32 in)
-  **70 mm** (2 3/4 in)

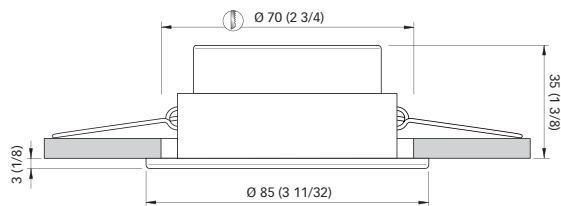

\*Other finishes available upon request / Altre finiture su richiesta

Dimensions in mm (inch)



## NK

The NK line has been created to fit the Nikita downlights. These decorative accessories are now available for one or more Nikita downlights.

**Nikita downlights are not included in the packaging.**

Le cornici NK sono state appositamente create per i faretti Nikita. Sono accessori decorativi disponibili per l'installazione di uno o più faretti. **I faretti Nikita non sono inclusi nella confezione.**



NK L1





NK L2



NK L3

**AISI 316 Stainless Steel**  
**Acciaio Inox AISI 316**

**Finishes / Finiture\***

-  Mirror polished / Inox lucido
-  Satin / Satinato
-  White 9010 / Bianco 9010

\*Other finishes available upon request / Altre finiture su richiesta

For interiors / Per interni



Dimensions / Dimensioni

Model Modello	N° spot N° faretti	Dimensions Dimensioni			Wheelbase Interasse
		A	B	C	
NK L1	1	A	B	C	D
		100 mm	100 mm	4 mm	-
		3 15/16 in	3 15/16 in	5/32 in	-
NK L2	2	A	B	C	D
		100 mm	192 mm	4 mm	92,25 mm
		3 15/16 in	7 9/16 in	5/32 in	3 5/8 in
NK L3	3	A	B	C	D
		100 mm	284 mm	4 mm	92,25 mm
		3 15/16 in	11 3/16 in	5/32 in	3 5/8 in

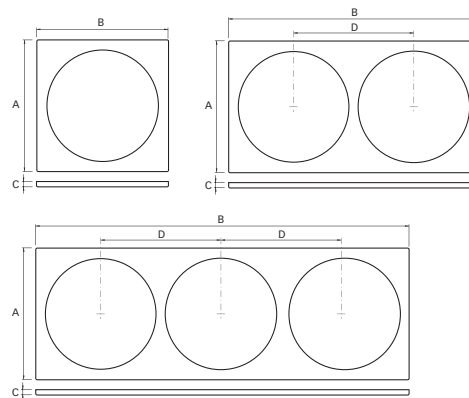

Dimensions in mm (inch)

## CHIARA - POWER LED



<b>Voltage system / Sistema</b>	<b>12 V / 24 V</b>
<b>Light source / Sorgente</b>	<b>POWER LED</b>
Operating voltage / Voltaggio	10 - 30 Vdc
<b>Power consumption / Potenza consumo</b>	<b>4 W</b>
Ampère consumption / Consumo Ampère	0,3 A @ 12 V / 0,16 A @ 24 V
LED protection / Protezione LED	Against inversion of polarity / Contro l'inversione di polarità
	Spike protected / Picchi di voltaggio $\pm$ 500 V
Polarity sensitive / Polarità	Yes / Sì
Dimming / Dimmerazione	Yes, with LDM1 / Sì, con LDM1

**Beam 55° / Angolo 55°**

**Distance / Distanza**

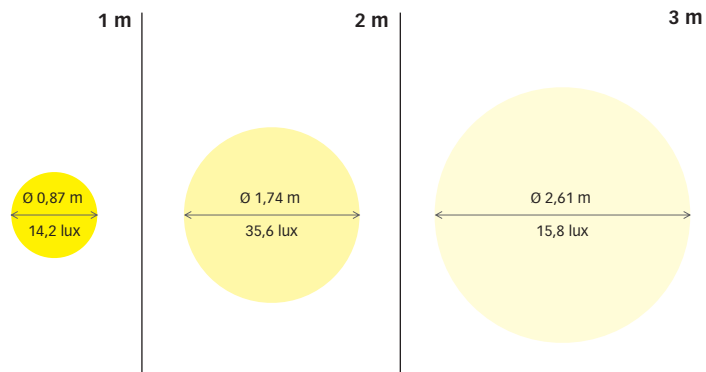
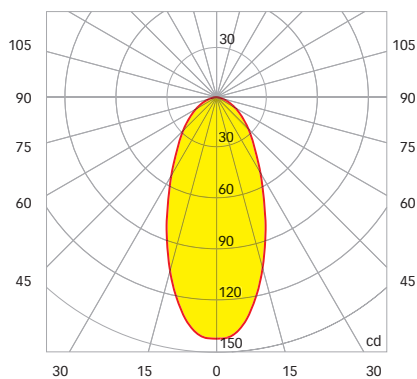

**Certifications / Certificazioni**



# CHIARA - POWER LED

# RECESSED LED DOWNLIGHTS FARETTI LED AD INCASSO

For exterior and interior applications / Per esterni ed interni



- Light color / Colore Luce**
- Daylight / Bianco Naturale
  - Warm White / Bianco Caldo
- Material / Materiale**      **AISI 316 Stainless Steel / Acciaio Inox**
- Finishes / Finiture\***
- Mirror polished / Inox lucido
  - Satin / Satinato
  - White 9010 / Bianco 9010

## Dimensions / Dimensioni

- 28 mm** (1 5/64 in)
- 87 mm** (3 7/16 in)
- 66 mm** (2 19/32 in)

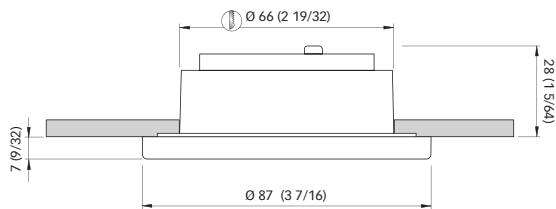

\*Other finishes available upon request / Altre finiture su richiesta

Dimensions in mm (inch)



## SONIA - POWER LED



<b>Voltage system / Sistema</b>	<b>12 V / 24 V</b>
<b>Light source / Sorgente</b>	<b>POWER LED</b>
Operating voltage / Voltaggio	10 - 30 Vdc
<b>Power consumption / Potenza consumo</b>	<b>4 W</b>
Ampère consumption / Consumo Ampère	0,3 A @ 12 V / 0,16 A @ 24 V
LED protection / Protezione LED	Against inversion of polarity / Contro l'inversione di polarità
	Spike protected / Picchi di voltaggio $\pm$ 500 V
Polarity sensitive / Polarità	Yes / Sì
Dimming / Dimmerazione	Yes, with LDM1 / Sì, con LDM1

Beam 60° / Angolo 60°

Distance / Distanza

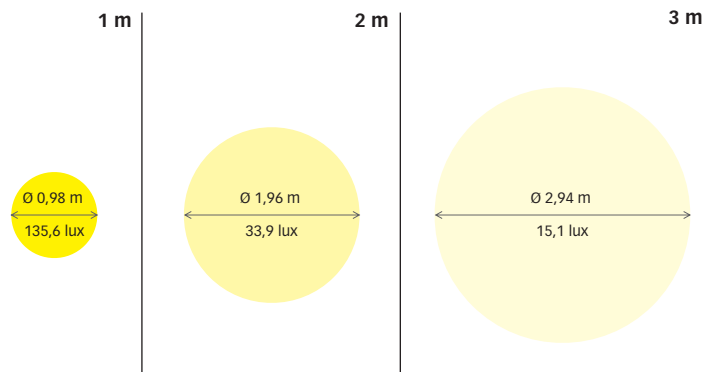
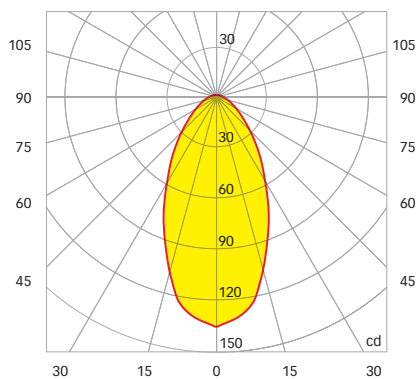

Certifications / Certificazioni



# SONIA - POWER LED

# RECESSED LED DOWNLIGHTS FARETTI LED AD INCASSO



For exterior and interior applications / Per esterni ed interni



AISI 316 Stainless Steel  
Acciaio Inox AISI 316

- Light color / Colore Luce**
- Daylight / Bianco Naturale
  - Warm White / Bianco Caldo
- Material / Materiale**      **AISI 316 Stainless Steel / Acciaio Inox**
- Finishes / Finiture\***
- Mirror polished / Inox lucido
  - Satin / Satinato
  - White 9010 / Bianco 9010

### Dimensions / Dimensioni

-  **33 mm** (1 19/32 in)
-  **105 mm** (4 9/64 in)
-  **80 mm** (3 5/32 in)

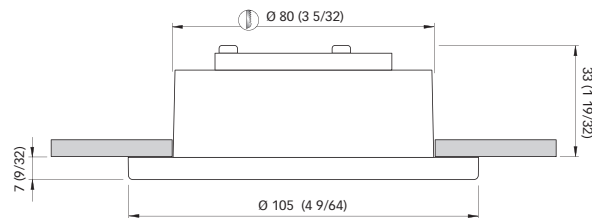

Dimensions in mm (inch)

\*Other finishes available upon request / Altre finiture su richiesta



**NEW | THEKLA - LED**

<b>Voltage system / Sistema</b>	<b>12 V / 24 V</b>
<b>Light source / Sorgente</b>	<b>138 LED - High luminosity / Alta luminosità</b>
Operating voltage / Voltaggio	10 - 30 Vdc
<b>Power consumption / Potenza consumo</b>	<b>9 W</b>
Ampère consumption / Consumo Ampère	0,75 A @ 12 V / 0,38 A @ 24 V
LED protection / Protezione LED	Against inversion of polarity / Contro l'inversione di polarità
	Spike protected / Picchi di voltaggio $\pm$ 500 V
Polarity sensitive / Polarità	Yes / Sì
Dimming / Dimmerazione	Yes, with LDM1 / Sì, con LDM1

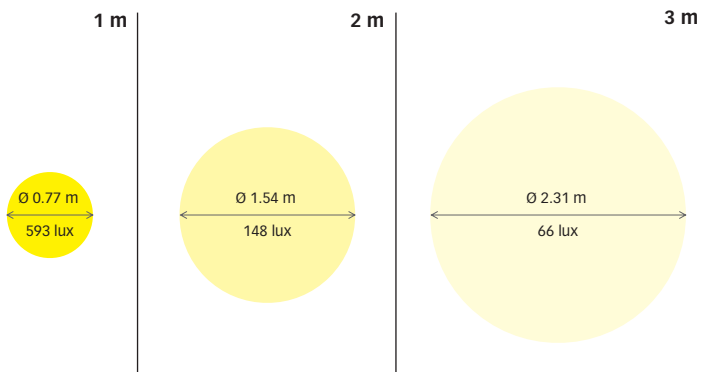
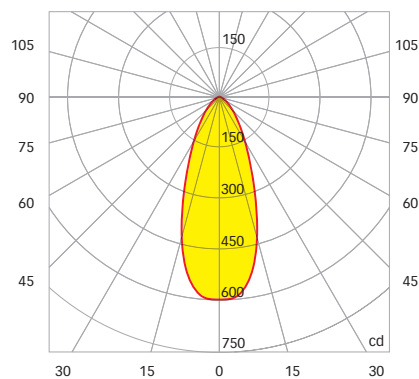
**Beam 50° / Angolo 50°****Distance / Distanza****Certifications / Certificazioni**

QUICK MARINE LIGHTING



**NEW** | THEKLA - LED

**RECESSED LED DOWNLIGHTS  
FARETTI LED AD INCASSO**

For exterior and interior applications / Per esterni ed interni



- Light color / Colore Luce**
- Daylight / Bianco Naturale
  - Warm White / Bianco Caldo
- Material / Materiale**      **AISI 316 Stainless Steel / Acciaio Inox**
- Finishes / Finiture\***
- Mirror polished / Inox lucido
  - Satin / Satinato
  - White 9010 / Bianco 9010

**Dimensions / Dimensioni**

- 25 mm (63/64 in)**
- 155 mm (6 7/64 in)**
- 114 mm (4 31/64 in)**

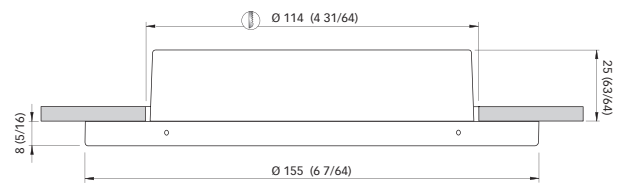

\*Other finishes available upon request / Altre finiture su richiesta

Dimensions in mm (inch)



**NEW | CAMILLA - LED**

<b>Voltage system / Sistema</b>	<b>12 V / 24 V</b>
<b>Light source / Sorgente</b>	<b>138 LED - High luminosity / Alta luminosità</b>
Operating voltage / Voltaggio	10 - 30 Vdc
<b>Power consumption / Potenza consumo</b>	<b>9 W</b>
Ampère consumption / Consumo Ampère	0,75 A @ 12 V / 0,38 A @ 24 V
LED protection / Protezione LED	Against inversion of polarity / Contro l'inversione di polarità
	Spike protected / Picchi di voltaggio $\pm$ 500 V
Polarity sensitive / Polarità	Yes / Sì
Dimming / Dimmerazione	Yes, with LDM1 / Sì, con LDM1

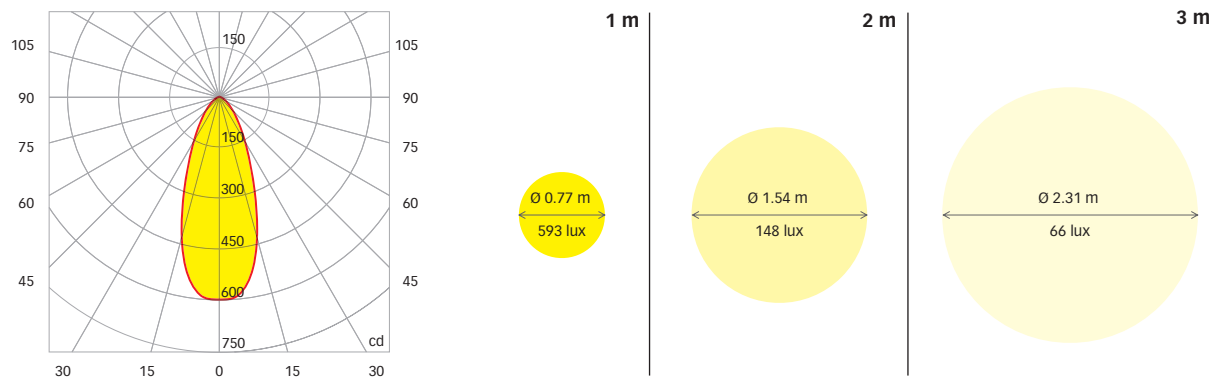
**Beam 50° / Angolo 50°****Distance / Distanza****Certifications / Certificazioni**

QUICK MARINE LIGHTING



**NEW** | CAMILLA - LED

## RECESSED LED DOWNLIGHTS FARETTI LED AD INCASSO

For exterior and interior applications / Per esterni ed interni



- Light color / Colore Luce**
- Daylight / Bianco Naturale
  - Warm White / Bianco Caldo
- Material / Materiale** AISI 316 Stainless Steel / Acciaio Inox
- Finishes / Finiture\***
- Mirror polished / Inox lucido

### Dimensions / Dimensioni

-  **25 mm** (63/64 in)
-  **155 mm** (6 7/64 in)
-  **114 mm** (4 31/64 in)

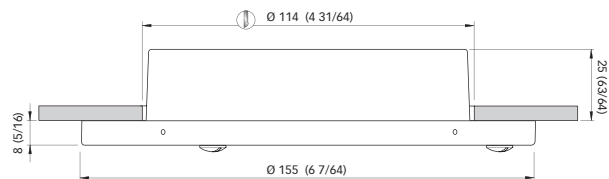

Dimensions in mm (inch)

\*Other finishes available upon request / Altre finiture su richiesta

QUICK MARINE LIGHTING



**NEW | JD - POWER LED**



<b>Voltage system / Sistema</b>	<b>12 V / 24 V</b>
<b>Light source / Sorgente</b>	<b>POWER LED</b>
Operating voltage / Voltaggio	8 - 30 Vdc
<b>Power consumption / Potenza consumo</b>	<b>1,5 W</b>
Ampère consumption / Consumo Ampère	0,12 A @ 12 V / 0,06 A @ 24 V
LED protection / Protezione LED	Spike protected / Picchi di voltaggio $\pm$ 500 V
Polarity sensitive / Polarità	No

**Beam 25° / Angolo 25°**

**Distance / Distanza**

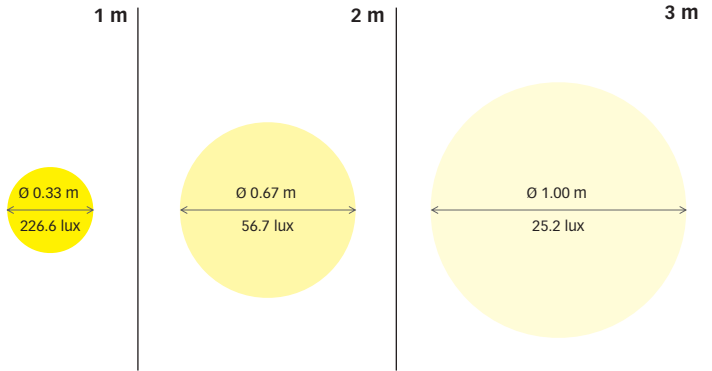
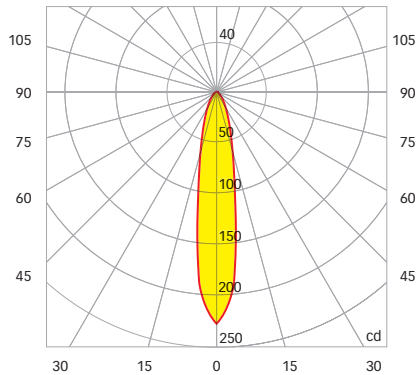

**Certifications / Certificazioni**



**NEW** | JD - POWER LED



**RECESSED LED DOWNLIGHTS  
FARETTI LED AD INCASSO**

For exterior and interior applications / Per esterni ed interni



- Light color / Colore Luce**
- Daylight / Bianco Naturale
  - Warm White / Bianco Caldo
- Material / Materiale**      **AISI 316 Stainless Steel / Acciaio Inox**
- Finishes / Finiture\***
- Mirror polished / Inox lucido
  - Satin / Satinato
  - White 9010 / Bianco 9010

**Dimensions / Dimensioni**

-  **19 mm** (3/4 in)
-  **36 mm** (1 27/64 in)
-  **25 mm** (63/64 in)

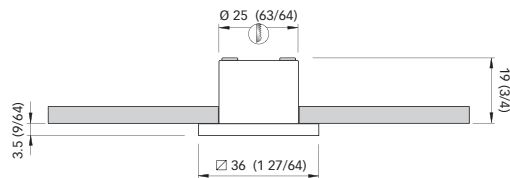

\*Other finishes available upon request / Altre finiture su richiesta

Dimensions in mm (inch)



**NEW | EDWIN - LED****HIGHER LUMINOSITY, LOWER CONSUMPTION**

The new LED downlights are equipped with a multi-voltage (12-24 V) integrated LED board.  
They are also available in the IP65 version for outdoor applications.

**MAGGIORE LUMINOSITA', MINORE CONSUMO**

I nuovi faretto LED sono dotati di scheda LED integrata multivoltaggio (12/24 V).  
Sono disponibili anche nella versione per esterno IP65.

Voltage system / Sistema	12 V / 24 V
Light source / Sorgente	22 LED - High Luminosity / Alta Luminosità
Operating voltage / Voltaggio	8 - 30 Vdc
Power consumption / Potenza consumo	2 W
Ampère consumption / Consumo Ampère	0,15 A @ 12 V / 0,08 A @ 24 V
LED protection / Protezione LED	Against inversion of polarity / Contro l'inversione di polarità
	Spike protected / Picchi di voltaggio $\pm$ 500 V
Polarity sensitive / Polarità	Si/Yes
Dimming / Dimmerazione	Yes, with ZDIM100 / Si, con ZDIM100

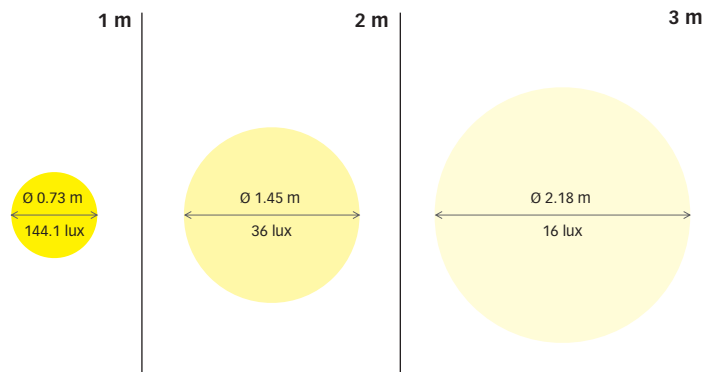
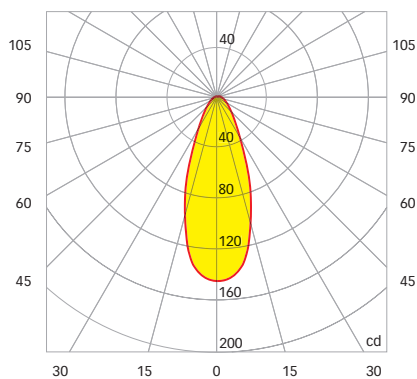
**Beam 40° / Angolo 40°****Distance / Distanza****Certifications / Certificazioni**

QUICK MARINE LIGHTING



**NEW | EDWIN - LED****RECESSED LED DOWNLIGHTS  
FARETTI LED AD INCASSO**

For exterior and interior applications / Per esterni ed interni



- Light color / Colore Luce**
- Daylight / Bianco Naturale
  - Warm White / Bianco Caldo
  - Red / Rosso
  - Bicolor - Warm white and blue  
Bicolore - Bianco caldo e blu

**Material / Materiale** AISI 316 Stainless Steel / Acciaio Inox

- Finishes / Finiture\***
- Mirror polished / Inox lucido
  - Satin / Satinato
  - White 9010 / Bianco 9010

\*Other finishes available upon request / Altre finiture su richiesta

**EDWIN IP40** with spring installation  
**EDWIN IP40** con fissaggio a molle



**Dimensions / Dimensioni**

**16 mm** (5/8 in)

**72 mm** (2 53/64 in)

**54 mm** (2 1/8 in)

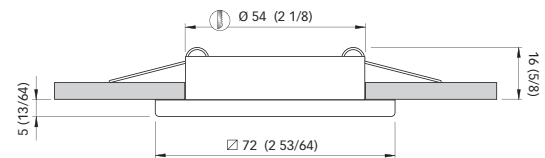

**EDWIN IP65** with screw base installation  
**EDWIN IP65** con fissaggio a viti



**Dimensions / Dimensioni**

**13 mm** (33/64 in)

**72 mm** (2 53/64 in)

**54 mm** (2 1/8 in)

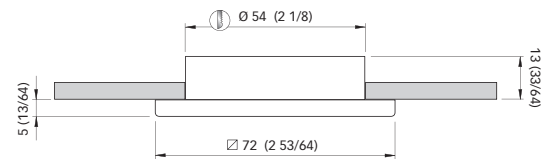

Dimensions in mm (inch)



**NEW | BRYAN - LED****HIGHER LUMINOSITY, LOWER CONSUMPTION**

The new LED downlights are equipped with a multi-voltage (12-24 V) integrated LED board. They are also available in the IP65 version for outdoor applications.

**MAGGIORE LUMINOSITA', MINORE CONSUMO**

I nuovi faretto LED sono dotati di scheda LED integrata multivoltaggio (12/24 V). Sono disponibili anche nella versione per esterno IP65.

Voltage system / Sistema	12 V / 24 V
Light source / Sorgente	22 LED - High Luminosity / Alta Luminosità
Operating voltage / Voltaggio	8 - 30 Vdc
Power consumption / Potenza consumo	2 W
Ampère consumption / Consumo Ampère	0,15 A @ 12 V / 0,08 A @ 24 V
LED protection / Protezione LED	Against inversion of polarity / Contro l'inversione di polarità
	Spike protected / Picchi di voltaggio $\pm$ 500 V
Polarity sensitive / Polarità	Si/Yes
Dimming / Dimmerazione	Yes, with ZDIM100 / Si, con ZDIM100

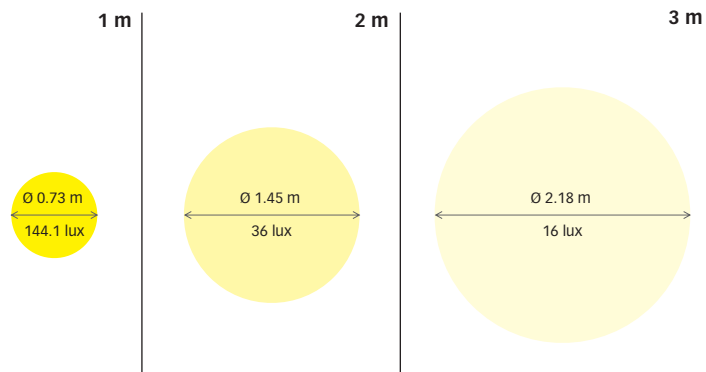
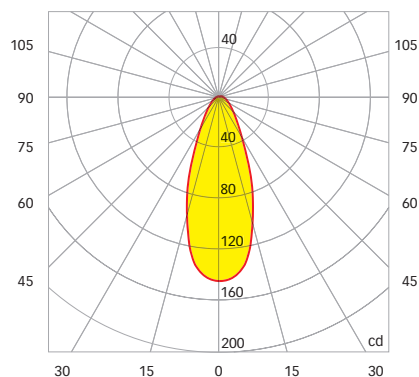
**Beam 40° / Angolo 40°****Distance / Distanza****Certifications / Certificazioni**

For exterior and interior applications / Per esterni ed interni



- Light color / Colore Luce**
- Daylight / Bianco Naturale
  - Warm White / Bianco Caldo
  - Red / Rosso
  - Bicolor - Warm white and blue  
Bicolore - Bianco caldo e blu

- Material / Materiale** AISI 316 Stainless Steel / Acciaio Inox
- Finishes / Finiture\***
- Mirror polished / Inox lucido
  - Satin / Satinato
  - White 9010 / Bianco 9010

\*Other finishes available upon request / Altre finiture su richiesta

**BRYAN IP40 with spring installation**  
**BRYAN IP40 con fissaggio a molle**



**Dimensions / Dimensioni**

- 16 mm (5/8 in)**
- 72 mm (2 53/64 in)**
- 54 mm (2 1/8 in)**

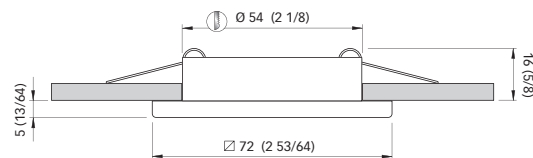

**BRYAN IP65 with screw base installation**  
**BRYAN IP65 con fissaggio a viti**



**Dimensions / Dimensioni**

- 13 mm (33/64 in)**
- 72 mm (2 53/64 in)**
- 54 mm (2 1/8 in)**

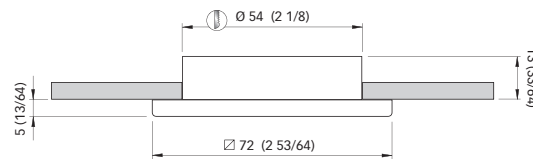

Dimensions in mm (inch)



## MARINA - POWER LED



Voltage system / Sistema	12 V / 24 V
Light source / Sorgente	POWER LED
Operating voltage / Voltaggio	10 - 30 Vdc
Power consumption / Potenza consumo	4 W
Ampère consumption / Consumo Ampère	0,3 A @ 12 V / 0,16 A @ 24 V
LED protection / Protezione LED	Against inversion of polarity / Contro l'inversione di polarità
	Spike protected / Picchi di voltaggio $\pm$ 500 V
Polarity sensitive / Polarità	Yes / Sì
Dimming / Dimmerazione	Yes, with LDM1 / Sì, con LDM1

Beam 50° / Angolo 50°

Distance / Distanza

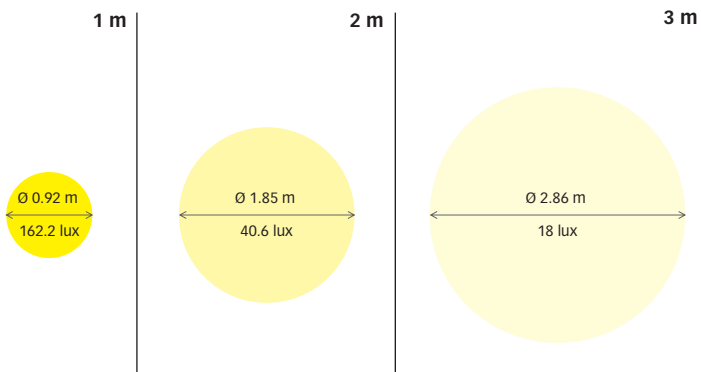
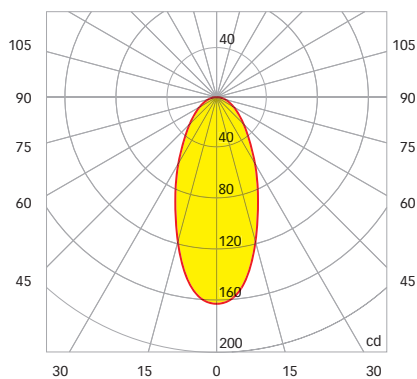

Certifications / Certificazioni



QUICK MARINE LIGHTING



# MARINA - POWER LED

# RECESSED LED DOWNLIGHTS FARETTI LED AD INCASSO

For exterior and interior applications / Per esterni ed interni



1



- Light color / Colore Luce**
- Daylight / Bianco Naturale
  - Warm White / Bianco Caldo
- Material / Materiale**      **AISI 316 Stainless Steel / Acciaio Inox**
- Finishes / Finiture\***
- Mirror polished / Inox lucido
  - Satin / Satinato
  - White 9010 / Bianco 9010

## Dimensions / Dimensioni

- 34 mm** (1 5/16 in)
- 72 mm** (2 53/64 in)
- 66 mm** (2 19/32 in)

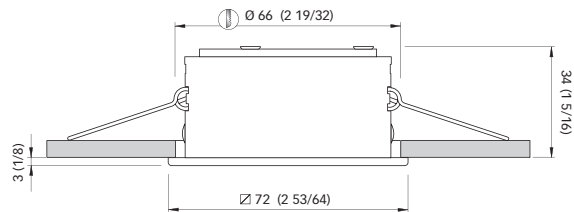

Dimensions in mm (inch)

\*Other finishes available upon request / Altre finiture su richiesta



## NEW | KRISTINE - POWER LED



<b>Voltage system / Sistema</b>	<b>12 V / 24 V</b>
<b>Light source / Sorgente</b>	<b>POWER LED</b>
Operating voltage / Voltaggio	10 - 30 Vdc
<b>Power consumption / Potenza consumo</b>	<b>7 W</b>
Ampère consumption / Consumo Ampère	0,58 A @ 12 V / 0,29 A @ 24 V
LED protection / Protezione LED	Against inversion of polarity / Contro l'inversione di polarità
	Spike protected / Picchi di voltaggio $\pm$ 500 V
Polarity sensitive / Polarità	Yes / Sì
Dimming / Dimmerazione	Yes, with LDM1 / Sì, con LDM1

**Beam 80° / Angolo 80°**

**Distance / Distanza**

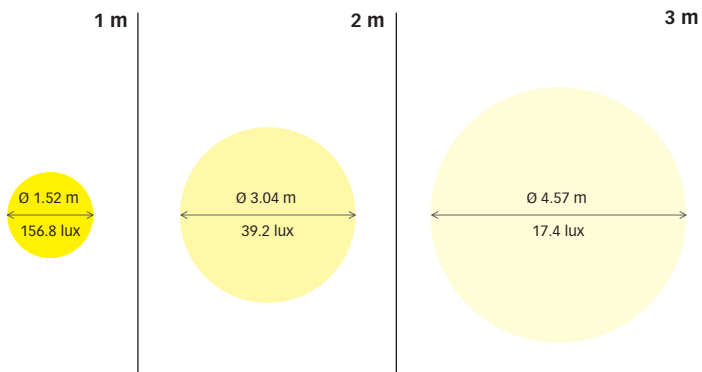
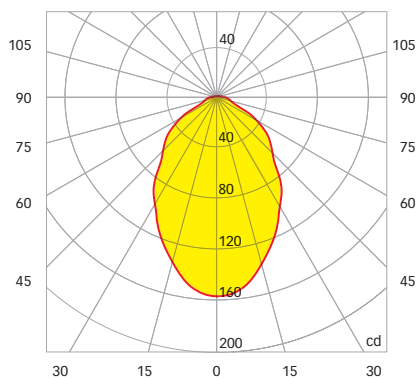

**Certifications / Certificazioni**



# NEW | KRISTINE - POWER LED

# RECESSED LED DOWNLIGHTS FARETTI LED AD INCASSO



For interiors / Per interni

IP40 113 59



- Light color / Colore Luce**
- Daylight / Bianco Naturale
  - Warm White / Bianco Caldo
- Material / Materiale**      **AISI 316 Stainless Steel / Acciaio Inox**
- Finishes / Finiture\***
- Mirror polished / Inox lucido
  - Satin / Satinato
  - White 9010 / Bianco 9010

### Dimensions / Dimensioni

-  **59 mm** (5 5/16 in)
-  **113 mm** (4 29/64 in)
-  **92X95 mm** (3 5/8 x 3 3/4 in)

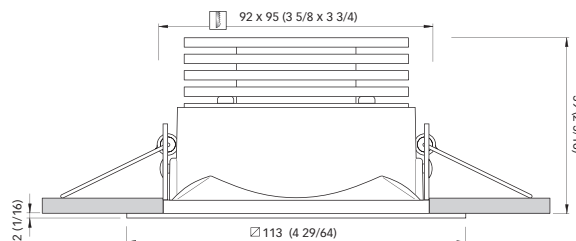

Dimensions in mm (inch)

\*Other finishes available upon request / Altre finiture su richiesta



## NEW | VANESSA - POWER LED



<b>Voltage system / Sistema</b>	<b>12 V / 24 V</b>
<b>Light source / Sorgente</b>	<b>POWER LED</b>
Operating voltage / Voltaggio	10 - 30 Vdc
<b>Power consumption / Potenza consumo</b>	<b>7 W</b>
Ampère consumption / Consumo Ampère	0,58 A @ 12 V / 0,29 A @ 24 V
LED protection / Protezione LED	Against inversion of polarity / Contro l'inversione di polarità
	Spike protected / Picchi di voltaggio $\pm$ 500 V
Polarity sensitive / Polarità	Yes / Sì
Dimming / Dimmerazione	Yes, with LDM1 / Sì, con LDM1

**Beam 80° / Angolo 80°**

**Distance / Distanza**

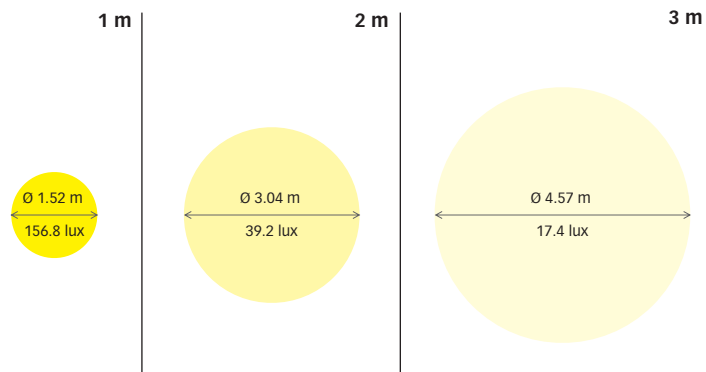
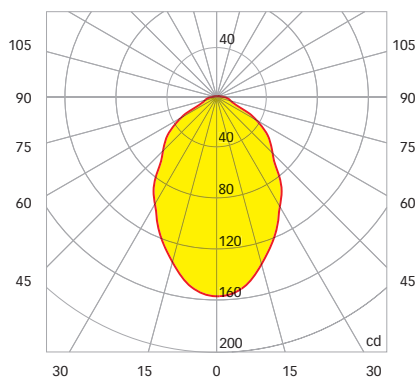

**Certifications / Certificazioni**



# NEW | VANESSA - POWER LED

# RECESSED LED DOWNLIGHTS FARETTI LED AD INCASSO

For interiors / Per interni



- Light color / Colore Luce**
- Daylight / Bianco Naturale
  - Warm White / Bianco Caldo
- Material / Materiale**      **AISI 316 Stainless Steel / Acciaio Inox**
- Finishes / Finiture\***
- Mirror polished / Inox lucido
  - Satin / Satinato
  - White 9010 / Bianco 9010

### Dimensions / Dimensioni

 **59 mm** (2 5/16 in)

 **113 mm** (4 29/64 in)

 **90X90 mm** (3 35/64 x 3 35/64 in)

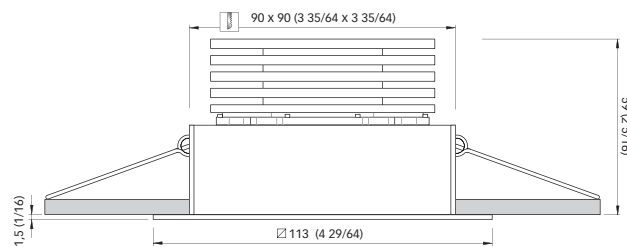

Dimensions in mm (inch)

\*Other finishes available upon request / Altre finiture su richiesta





**NEW | DEMETRA - POWER LED**

**RECESSED LED DOWNLIGHTS  
FARETTI LED AD INCASSO**

For exterior and interior applications / Per esterni ed interni



- Light color / Colore Luce**
- Daylight / Bianco Naturale
  - Warm White / Bianco Caldo
- Material / Materiale**      **AISI 316 Stainless Steel / Acciaio Inox**
- Finishes / Finiture\***
- Mirror polished / Inox lucido
  - Satin / Satinato
  - White 9010 / Bianco 9010

**Dimensions / Dimensioni**

- 54 mm** (2 9/64 in)
- 112 mm** (4 29/64 in)
- 85X85 mm** (3 11/32 x 3 11/32 in)

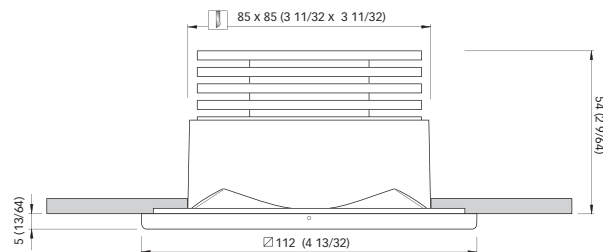

Dimensions in mm (inch)

\*Other finishes available upon request / Altre finiture su richiesta



LED SURFACE-MOUNT FIXTURES  
PLAFONIERE A LED

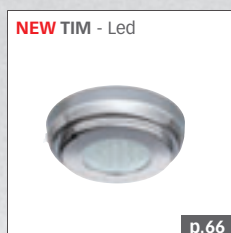

IP40 - Ø 90 / Thickness 22

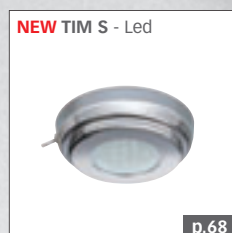

IP40 - Ø 90 / Thickness 22

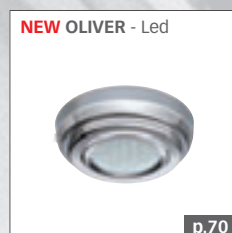

IP40 - Ø 90 / Thickness 23

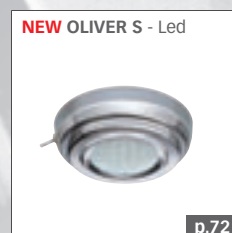

IP40 - Ø 90 / Thickness 23

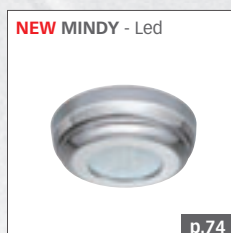

IP40 - Ø 90 / Thickness 25



IP40 - Ø 90 / Thickness 25

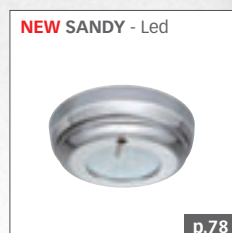

IP40 - Ø 90 / Thickness 25

IP40 = for interior applications only  
IP40 = solo per interni

IP65 = for interior and exterior applications  
IP65 = per interni ed esterni

Dimensions of diameter/maximum trim ring side length and recess are listed in mm  
Le dimensioni del diametro/lato max cornice e del recesso sono indicati in mm

# LED SURFACE-MOUNT FIXTURES

FOR INTERIORS

SURFACE-MOUNT FIXTURES FOR INTERIOR APPLICATIONS.  
TRIM RING IN AISI 316 STAINLESS STEEL  
LED LIGHT SOURCE.

PLAFONIERA PER INTERNI.  
CORNICI IN ACCIAIO INOX AISI 316.  
SORGENTE DI LUCE A LED

MODELS IN ALPHABETICAL ORDER

<b>NEW</b>   MINDY	p. 74
<b>NEW</b>   MINDY S	p. 76
<b>NEW</b>   OLIVER	p. 70
<b>NEW</b>   OLIVER S	p. 72
<b>NEW</b>   SANDY	p. 78
<b>NEW</b>   TIM	p. 66
<b>NEW</b>   TIM S	p. 68

**NEW | TIM - LED****HIGHER LUMINOSITY, LOWER CONSUMPTION**

The new LED surface-mount fixtures are equipped with a multi-voltage (12-24 V) integrated LED board.

**MAGGIORE LUMINOSITA', MINORE CONSUMO**

I nuovi faretti LED a plafoniera sono dotati di scheda LED integrata multivoltaggio (12/24 V).

<b>Voltage system / Sistema</b>	<b>12 V / 24 V</b>
<b>Light source / Sorgente</b>	<b>22 LED - High Luminosity / Alta Luminosità</b>
Operating voltage / Voltaggio	8 - 30 Vdc
<b>Power consumption / Potenza consumo</b>	<b>2 W</b>
Ampère consumption / Consumo Ampère	0,15 A @ 12 V / 0,08 A @ 24 V
LED protection / Protezione LED	Against inversion of polarity / Contro l'inversione di polarità
	Spike protected / Picchi di voltaggio $\pm$ 500 V
Polarity sensitive / Polarità	Si/Yes
Dimming / Dimmerazione	Yes, with ZDIM100 / Si, con ZDIM100

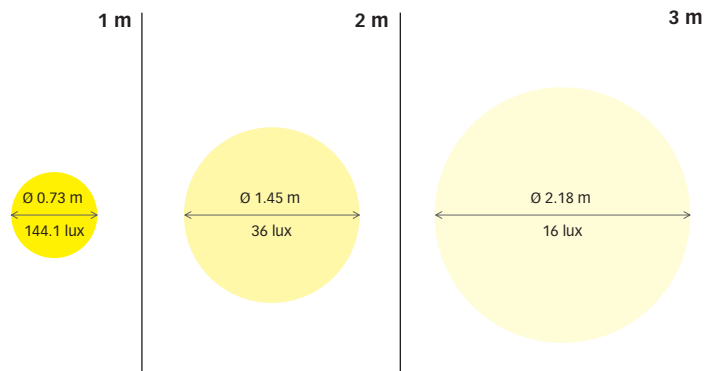
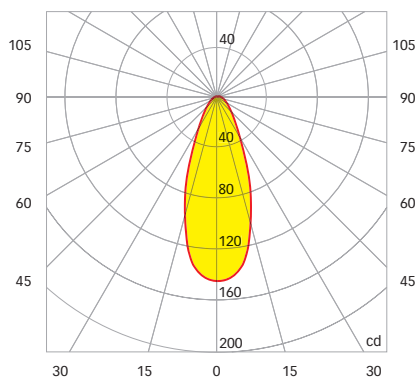
**Beam 40° / Angolo 40°****Distance / Distanza****Certifications / Certificazioni**

**NEW** | TIM - LED**LED SURFACE-MOUNT FIXTURES  
PLAFONIERA A LED**

For interiors / Per interni



- Light color / Colore Luce**
- Daylight / Bianco Naturale
  - Warm White / Bianco Caldo
  - Red / Rosso
  - Bicolor - Warm white and blue  
Bicolore - Bianco caldo e blu

**Material / Materiale** AISI 316 Stainless Steel / Acciaio Inox

- Finishes / Finiture\***
- Mirror polished / Inox lucido
  - Satin / Satinato
  - White 9010 / Bianco 9010

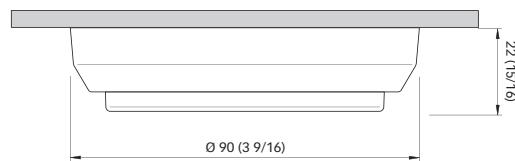
**Dimensions / Dimensioni**

\*Other finishes available upon request / Altre finiture su richiesta

Dimensions in mm (inch)

QUICK MARINE LIGHTING



**NEW | TIM S - LED****HIGHER LUMINOSITY, LOWER CONSUMPTION**

The new LED surface-mount fixtures are equipped with a multi-voltage (12-24 V) integrated LED board.

**MAGGIORE LUMINOSITA', MINORE CONSUMO**

I nuovi faretti LED a plafoniera sono dotati di scheda LED integrata multivoltaggio (12/24 V).

<b>Voltage system / Sistema</b>	<b>12 V / 24 V</b>
<b>Light source / Sorgente</b>	<b>22 LED - High Luminosity / Alta Luminosità</b>
Operating voltage / Voltaggio	8 - 30 Vdc
<b>Power consumption / Potenza consumo</b>	<b>2 W</b>
Ampère consumption / Consumo Ampère	0,15 A @ 12 V / 0,08 A @ 24 V
LED protection / Protezione LED	Against inversion of polarity / Contro l'inversione di polarità
	Spike protected / Picchi di voltaggio $\pm$ 500 V
Polarity sensitive / Polarità	Si/Yes
Dimming / Dimmerazione	Yes, with ZDIM100 / Si, con ZDIM100

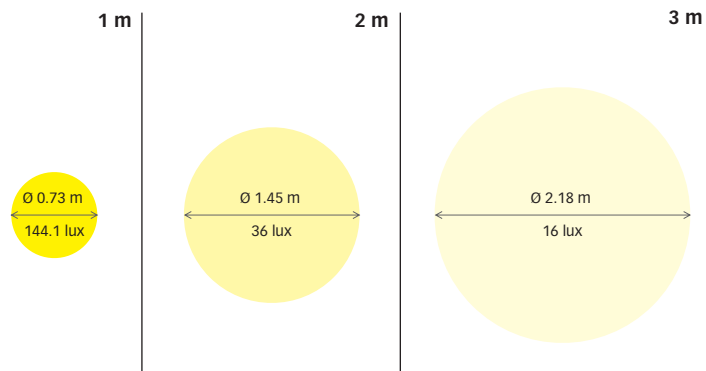
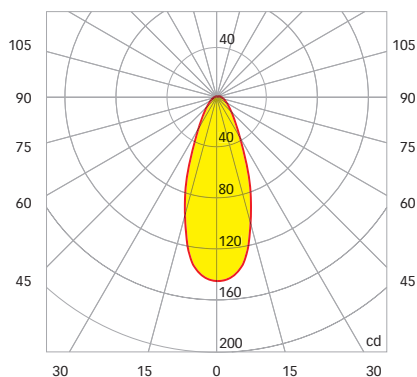
**Beam 40° / Angolo 40°****Distance / Distanza****Certifications / Certificazioni**

**NEW | TIM S - LED****LED SURFACE-MOUNT FIXTURES  
PLAFONIERA A LED**

For interiors / Per interni

With switch  
Con interruttore

- Light color / Colore Luce**
- Daylight / Bianco Naturale
  - Warm White / Bianco Caldo
  - Red / Rosso
- Material / Materiale**      **AISI 316 Stainless Steel / Acciaio Inox**
- Finishes / Finiture\***
- Mirror polished / Inox lucido
  - Satin / Satinato
  - White 9010 / Bianco 9010

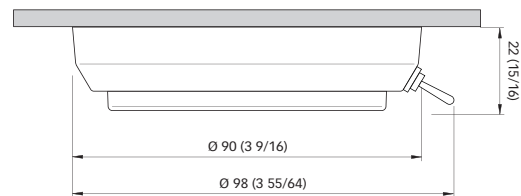
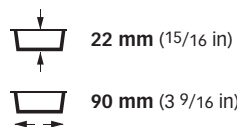
**Dimensions / Dimensioni**

\*Other finishes available upon request / Altre finiture su richiesta

Dimensions in mm (inch)

## NEW | OLIVER - LED



### HIGHER LUMINOSITY, LOWER CONSUMPTION

The new LED surface-mount fixtures are equipped with a multi-voltage (12-24 V) integrated LED board.

### MAGGIORE LUMINOSITA', MINORE CONSUMO

I nuovi faretti LED a plafoniera sono dotati di scheda LED integrata multivoltaggio (12/24 V).

Voltage system / Sistema	12 V / 24 V
Light source / Sorgente	22 LED - High Luminosity / Alta Luminosità
Operating voltage / Voltaggio	8 - 30 Vdc
Power consumption / Potenza consumo	2 W
Ampère consumption / Consumo Ampère	0,15 A @ 12 V / 0,08 A @ 24 V
LED protection / Protezione LED	Against inversion of polarity / Contro l'inversione di polarità
	Spike protected / Picchi di voltaggio $\pm$ 500 V
Polarity sensitive / Polarità	Si/Yes
Dimming / Dimmerazione	Yes, with ZDIM100 / Si, con ZDIM100

### Beam 40° / Angolo 40°

### Distance / Distanza

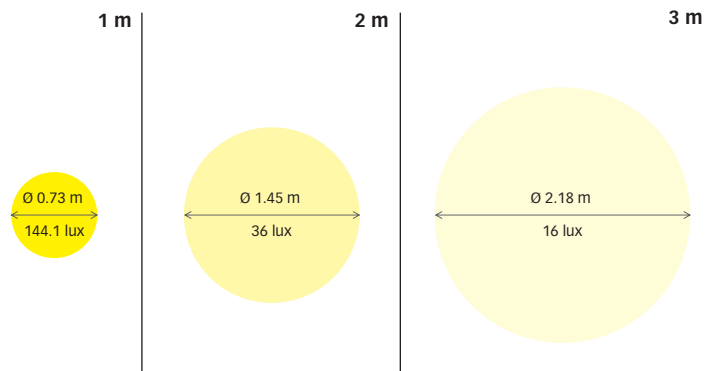
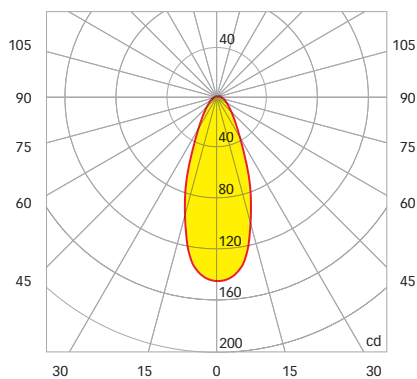

### Certifications / Certificazioni



**NEW | OLIVER - LED****LED SURFACE-MOUNT FIXTURES  
PLAFONIERA A LED**

For interiors / Per interni



- Light color / Colore Luce**
- Daylight / Bianco Naturale
  - Warm White / Bianco Caldo
  - Red / Rosso
  - Bicolor - Warm white and blue  
Bicolore - Bianco caldo e blu

**Material / Materiale** AISI 316 Stainless Steel / Acciaio Inox

- Finishes / Finiture\***
- Mirror polished / Inox lucido
  - Satin / Satinato
  - White 9010 / Bianco 9010

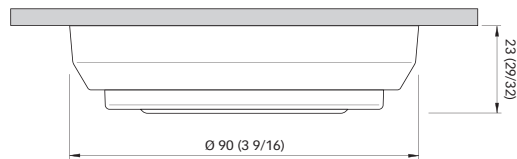
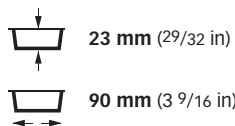
**Dimensions / Dimensioni**

\*Other finishes available upon request / Altre finiture su richiesta

Dimensions in mm (inch)

## NEW | OLIVER S - LED



### HIGHER LUMINOSITY, LOWER CONSUMPTION

The new LED surface-mount fixtures are equipped with a multi-voltage (12-24 V) integrated LED board.

### MAGGIORE LUMINOSITA', MINORE CONSUMO

I nuovi faretti LED a plafoniera sono dotati di scheda LED integrata multivoltaggio (12/24 V).

Voltage system / Sistema	12 V / 24 V
Light source / Sorgente	22 LED - High Luminosity / Alta Luminosità
Operating voltage / Voltaggio	8 - 30 Vdc
Power consumption / Potenza consumo	2 W
Ampère consumption / Consumo Ampère	0,15 A @ 12 V / 0,08 A @ 24 V
LED protection / Protezione LED	Against inversion of polarity / Contro l'inversione di polarità
	Spike protected / Picchi di voltaggio $\pm$ 500 V
Polarity sensitive / Polarità	Si/Yes
Dimming / Dimmerazione	Yes, with ZDIM100 / Si, con ZDIM100

Beam 40° / Angolo 40°

Distance / Distanza

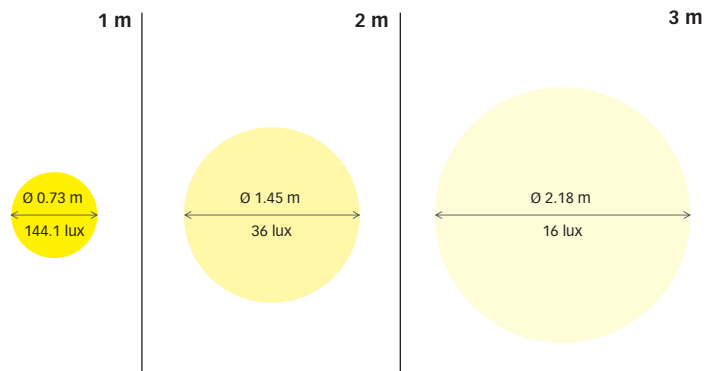
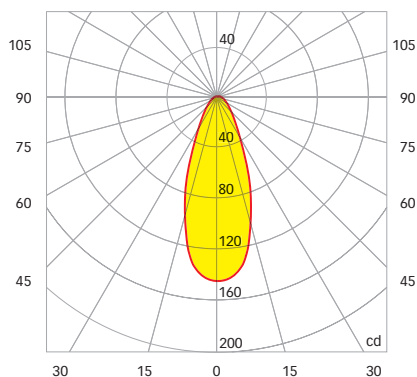

Certifications / Certificazioni



**NEW | OLIVER S - LED****LED SURFACE-MOUNT FIXTURES  
PLAFONIERA A LED**

For interiors / Per interni

With switch  
Con interruttore

- Light color / Colore Luce**
- Daylight / Bianco Naturale
  - Warm White / Bianco Caldo
  - Red / Rosso
- Material / Materiale**      **AISI 316 Stainless Steel / Acciaio Inox**
- Finishes / Finiture\***
- Mirror polished / Inox lucido
  - Satin / Satinato
  - White 9010 / Bianco 9010

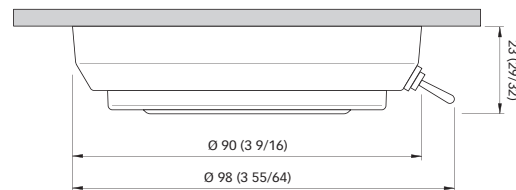
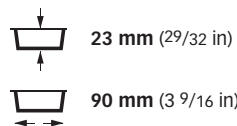
**Dimensions / Dimensioni**

\*Other finishes available upon request / Altre finiture su richiesta

Dimensions in mm (inch)

**NEW | MINDY - LED****HIGHER LUMINOSITY, LOWER CONSUMPTION**

The new LED surface-mount fixtures are equipped with a multi-voltage (12-24 V) integrated LED board.

**MAGGIORE LUMINOSITA', MINORE CONSUMO**

I nuovi faretti LED a plafoniera sono dotati di scheda LED integrata multivoltaggio (12/24 V).

<b>Voltage system / Sistema</b>	<b>12 V / 24 V</b>
<b>Light source / Sorgente</b>	<b>22 LED - High Luminosity / Alta Luminosità</b>
Operating voltage / Voltaggio	8 - 30 Vdc
<b>Power consumption / Potenza consumo</b>	<b>2 W</b>
Ampère consumption / Consumo Ampère	0,15 A @ 12 V / 0,08 A @ 24 V
LED protection / Protezione LED	Against inversion of polarity / Contro l'inversione di polarità
	Spike protected / Picchi di voltaggio $\pm$ 500 V
Polarity sensitive / Polarità	Si/Yes
Dimming / Dimmerazione	Yes, with ZDIM100 / Si, con ZDIM100

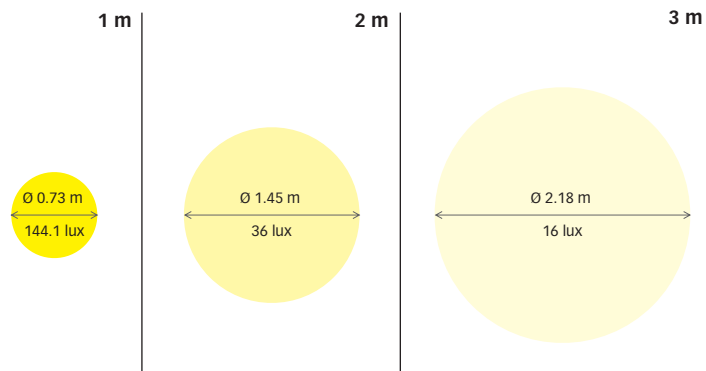
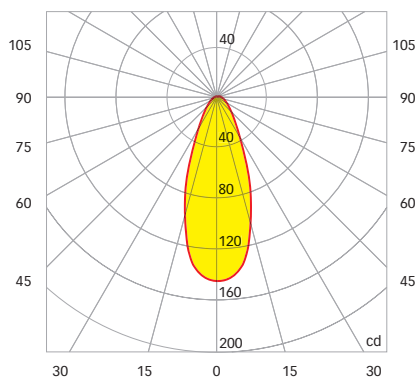
**Beam 40° / Angolo 40°****Distance / Distanza****Certifications / Certificazioni**

**NEW | MINDY - LED****LED SURFACE-MOUNT FIXTURES  
PLAFONIERA A LED**

For interiors / Per interni



- Light color / Colore Luce**
- Daylight / Bianco Naturale
  - Warm White / Bianco Caldo
  - Red / Rosso
  - Bicolor - Warm white and blue  
Bicolore - Bianco caldo e blu

**Material / Materiale** AISI 316 Stainless Steel / Acciaio Inox

- Finishes / Finiture\***
- Mirror polished / Inox lucido
  - Satin / Satinato
  - White 9010 / Bianco 9010

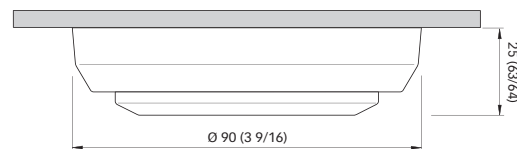
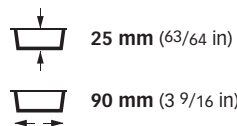
**Dimensions / Dimensioni**

\*Other finishes available upon request / Altre finiture su richiesta

Dimensions in mm (inch)

**NEW | MINDY S - LED****HIGHER LUMINOSITY, LOWER CONSUMPTION**

The new LED surface-mount fixtures are equipped with a multi-voltage (12-24 V) integrated LED board.

**MAGGIORE LUMINOSITA', MINORE CONSUMO**

I nuovi faretti LED a plafoniera sono dotati di scheda LED integrata multivoltaggio (12/24 V).

<b>Voltage system / Sistema</b>	<b>12 V / 24 V</b>
<b>Light source / Sorgente</b>	<b>22 LED - High Luminosity / Alta Luminosità</b>
Operating voltage / Voltaggio	8 - 30 Vdc
<b>Power consumption / Potenza consumo</b>	<b>2 W</b>
Ampère consumption / Consumo Ampère	0,15 A @ 12 V / 0,08 A @ 24 V
LED protection / Protezione LED	Against inversion of polarity / Contro l'inversione di polarità
	Spike protected / Picchi di voltaggio $\pm$ 500 V
Polarity sensitive / Polarità	Si/Yes
Dimming / Dimmerazione	Yes, with ZDIM100 / Si, con ZDIM100

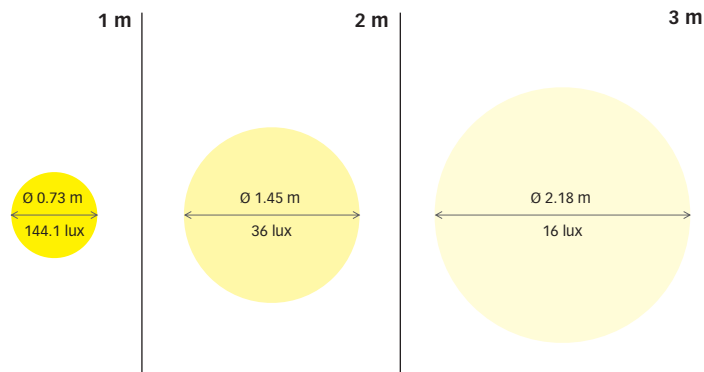
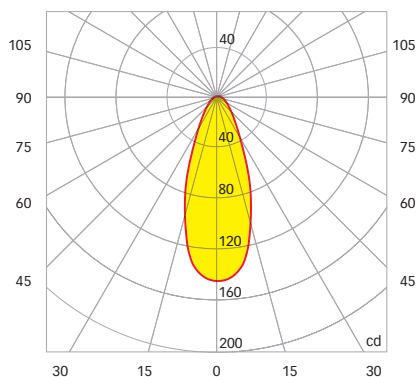
**Beam 40° / Angolo 40°****Distance / Distanza****Certifications / Certificazioni**

**NEW** | MINDY S - LED

**LED SURFACE-MOUNT FIXTURES  
PLAFONIERA A LED**

For interiors / Per interni



With switch  
Con interruttore

- Light color / Colore Luce**
- Daylight / Bianco Naturale
  - Warm White / Bianco Caldo
  - Red / Rosso
- Material / Materiale**      **AISI 316 Stainless Steel / Acciaio Inox**
- Finishes / Finiture\***
- Mirror polished / Inox lucido
  - Satin / Satinato
  - White 9010 / Bianco 9010

**Dimensions / Dimensioni**

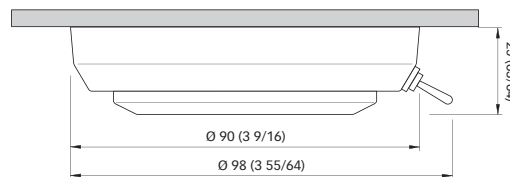
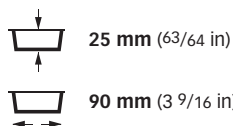

\*Other finishes available upon request / Altre finiture su richiesta

Dimensions in mm (inch)



**NEW | SANDY - LED****HIGHER LUMINOSITY, LOWER CONSUMPTION**

The new LED surface-mount fixtures are equipped with a multi-voltage (12-24 V) integrated LED board.

**MAGGIORE LUMINOSITA', MINORE CONSUMO**

I nuovi faretti LED a plafoniera sono dotati di scheda LED integrata multivoltaggio (12/24 V).

Voltage system / Sistema	12 V / 24 V
Light source / Sorgente	22 LED - High Luminosity / Alta Luminosità
Operating voltage / Voltaggio	8 - 30 Vdc
Power consumption / Potenza consumo	2 W
Ampère consumption / Consumo Ampère	0,15 A @ 12 V / 0,08 A @ 24 V
LED protection / Protezione LED	Against inversion of polarity / Contro l'inversione di polarità
	Spike protected / Picchi di voltaggio $\pm$ 500 V
Polarity sensitive / Polarità	Si/Yes
Dimming / Dimmerazione	Yes, with ZDIM100 / Si, con ZDIM100

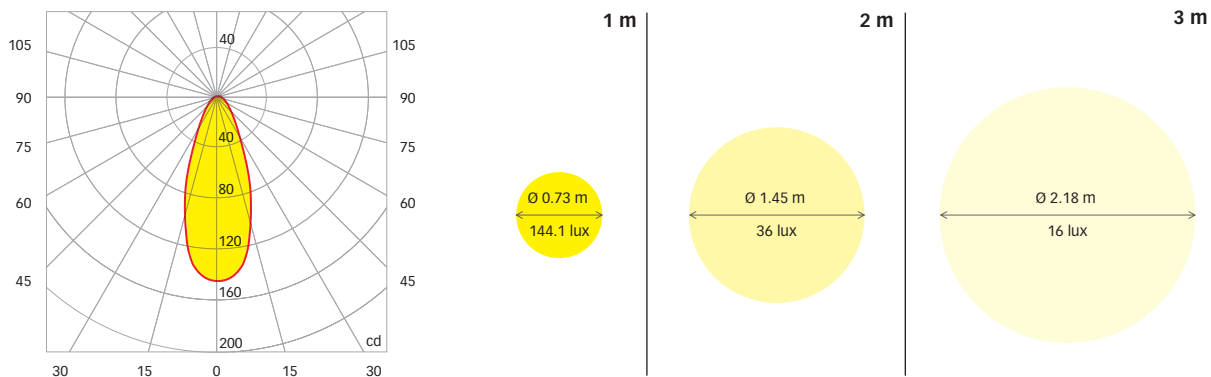
**Beam 40° / Angolo 40°****Distance / Distanza****Certifications / Certificazioni**

**NEW | SANDY - LED****LED SURFACE-MOUNT FIXTURES  
PLAFONIERA A LED**

For interiors / Per interni



**Light color / Colore Luce**

- Daylight / Bianco Naturale
- Warm White / Bianco Caldo
- Red / Rosso

**Material / Materiale** AISI 316 Stainless Steel / Acciaio Inox

**Finishes / Finiture\***

- Mirror polished / Inox lucido
- Satin / Satinato
- White 9010 / Bianco 9010

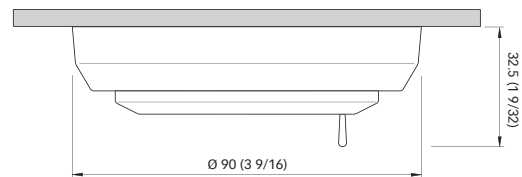
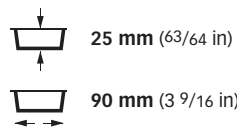
**Dimensions / Dimensioni**

Dimensions in mm (inch)

\*Other finishes available upon request / Altre finiture su richiesta

**LED READING & CHART TABLE LIGHTS  
LUCI DA LETTURA E DA CARTEGGIO A LED**

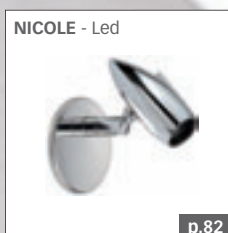

IP40 - Adjustable

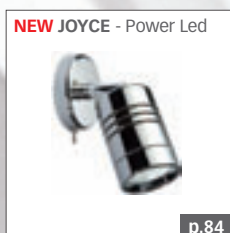

IP40 - Adjustable

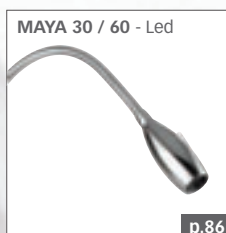

IP40 - Flexible

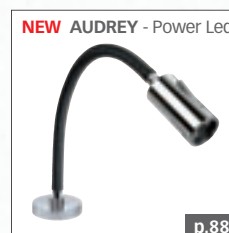

IP40 - Flexible



IP40 - Flexible

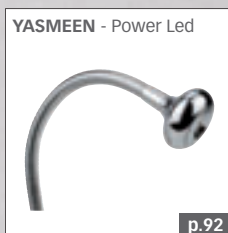

IP40 - Flexible

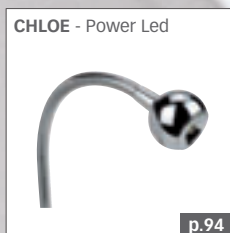

IP40 - Flexible

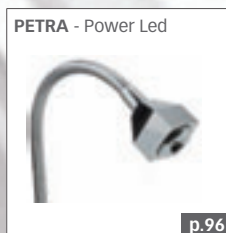

IP40 - Flexible

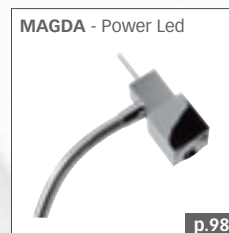

IP40 - Flexible

IP40 = for interior applications only  
IP40 = solo per interni

IP65 = for interior and exterior applications  
IP65 = per interni ed esterni

Dimensions of diameter/maximum trim ring side length and recess are listed in mm  
Le dimensioni del diametro/lato max cornice e del recesso sono indicati in mm

# LED READING & CHART TABLE LIGHTS

READING AND CHART TABLE LIGHTS.  
WALL AND SURFACE INSTALLATION.  
FLEXIBLE AND ADJUSTABLE.  
HIGH LUMINOSITY LED LIGHT SOURCE

LUCI DA LETTURA E DA CARTEGGIO.  
INSTALLAZIONE A PARETE E SU PIANO.  
FLESSIBILI E ORIENTABILI.  
SORGENTE DI LUCE A LED ALTA LUMINOSITA'.

MODELS IN ALPHABETICAL ORDER

<b>NEW</b>   AUDREY	p. 88
CHLOE	p. 94
<b>NEW</b>   JOYCE LED	p. 84
MAGDA	p. 98
MAYA 30/60	p. 86
NICOLE	p. 82
PETRA	p. 96
SHARK 30/50	p. 90
YASMEEN	p. 92

## NICOLE - LED

Voltage system / Sistema	12 V / 24 V
Light source / Sorgente	6 LED - High luminosity / 6 LED - Alta Luminosità
Operating voltage / Voltaggio	10 - 30 Vdc
Power consumption / Potenza consumo	1,2 W
Ampère consumption / Consumo Ampère	0,1 A @ 12 V / 0,05 A @ 24 V
LED protection / Protezione LED	Against inversion of polarity / Contro l'inversione di polarità
	Spike protected / Picchi di voltaggio $\pm$ 500 V
Polarity sensitive / Polarità	Yes / Sì

### Certifications / Certificazioni



### Dimensions / Dimensioni



20 mm (25/32 in)

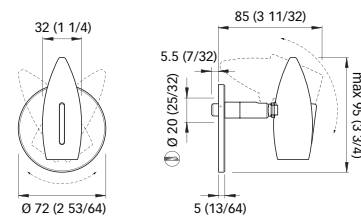

Dimensions in mm (inch)



With switch  
Con interruttore

**Light color / Colore Luce**

- Daylight / Bianco Naturale
- Cool White / Bianco Freddo

**Materials / Materiali**

- Chromed aluminium  
Alluminio cromato
- Anodized aluminium - Silver color  
Alluminio anodizzato - Colore argento



**NEW | JOYCE LED**

Voltage system / Sistema	<b>12 V / 24 V</b>
Light source / Sorgente	<b>POWER LED</b>
Operating voltage / Voltaggio	10 - 30 Vdc
Power consumption / Potenza consumo	<b>3 W</b>
Ampère consumption / Consumo Ampère	0,25 A @ 12 V / 0,13 A @ 24 V
LED protection / Protezione LED	Against inversion of polarity / Contro l'inversione di polarità
	Spike protected / Picchi di voltaggio $\pm$ 500 V
Polarity sensitive / Polarità	Yes / Sì

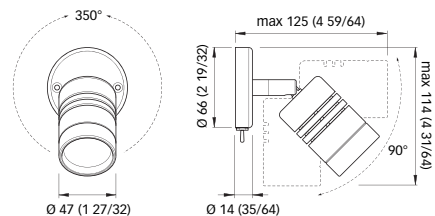
**Certifications / Certificazioni****Dimensions / Dimensioni**

Dimensions in mm (inch)



**NEW** | JOYCE LED

**LED READING LIGHTS  
LUCI DA LETTURA LED**

*Adjustable*  
READING LIGHT

IP40



With switch  
Con interruttore

Light color / Colore Luce     Daylight / Bianco Naturale

Materials / Materiali

- Chromed aluminium  
Alluminio cromato
- Anodized aluminium - Black color  
Alluminio anodizzato - Colore Nero



## MAYA 30/60 - LED

Voltage system / Sistema	12 V / 24 V
Light source / Sorgente	6 LED - High luminosity / 6 LED - Alta Luminosità
Operating voltage / Voltaggio	10 - 30 Vdc
Power consumption / Potenza consumo	1,2 W
Ampère consumption / Consumo Ampère	0,1 A @ 12 V / 0,05 A @ 24 V
LED protection / Protezione LED	Against inversion of polarity / Contro l'inversione di polarità
	Spike protected / Picchi di voltaggio $\pm$ 500 V
Polarity sensitive / Polarità	Yes / Sì

## Certifications / Certificazioni



## Dimensions / Dimensioni



20 mm (25/32 in)

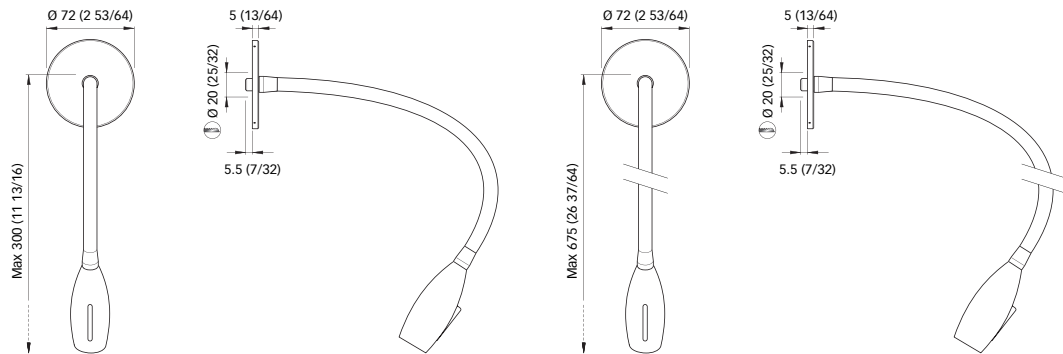

Dimensions in mm (inch)

## MAYA 30/60 - LED

LED READING LIGHTS  
LUCI DA LETTURA LEDFlexible  
READING LIGHT

IP40

With switch  
Con interruttore

Light color / Colore Luce  Daylight / Bianco Naturale  
 Cool White / Bianco Freddo

Materials / Materiali  Chromed aluminium  
 Alluminio cromato



Maya 30

Maya 60

## NEW | AUDREY - POWER LED

Voltage system / Sistema	12 V / 24 V
Light source / Sorgente	POWER LED
Operating voltage / Voltaggio	10 - 30 Vdc
Power consumption / Potenza consumo	1,5 W
Ampère consumption / Consumo Ampère	0,12 A @ 12 V / 0,06 A @ 24 V
LED protection / Protezione LED	Against inversion of polarity / Contro l'inversione di polarità Spike protected / Picchi di voltaggio ± 500 V
Polarity sensitive / Polarità	Yes / Sì

### Certifications / Certificazioni



### Dimensions / Dimensioni



20 mm (25/32 in)

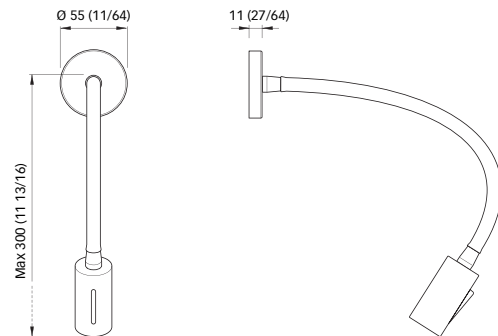

Dimensions in mm (inch)

**NEW** | AUDREY - POWER LED

**LED READING LIGHTS  
LUCI DA LETTURA LED**

Flexible  
READING LIGHT

IP40



With switch  
Con interruttore

**Light color / Colore Luce** ○ Daylight / Bianco Naturale

**Materials / Materiali**

- Chromed brass  
Ottone cromato
- Anodized aluminium  
Alluminio anodizzato

**Finish / Rivestimento**

- Black leather / Pelle nera
- Brown leather / Pelle marrone
- Black neoprene / Neoprene nero



Chromed brass  
Ottone cromato



Chromed brass and black neoprene  
Ottone cromato e neoprene nero



Chromed brass and black leather  
Ottone cromato e pelle nera



Anodized aluminium and brown leather  
Alluminio anodizzato e pelle marrone

QUICK MARINE LIGHTING



## SHARK 30/50 - POWER LED - LED

Voltage system / Sistema	12 V / 24 V
Light source / Sorgente	White POWER LED and Red LED
Operating voltage / Voltaggio	10 - 30 Vdc
Power consumption / Potenza consumo	1,5 W
Ampère consumption / Consumo Ampère	0,12 A @ 12 V / 0,06 A @ 24 V
LED protection / Protezione LED	Against inversion of polarity / Contro l'inversione di polarità Spike protected / Picchi di voltaggio $\pm$ 500 V
Polarity sensitive / Polarità	Yes / Sì

## Certifications / Certificazioni



## Dimensions / Dimensioni



20 mm (25/32 in)

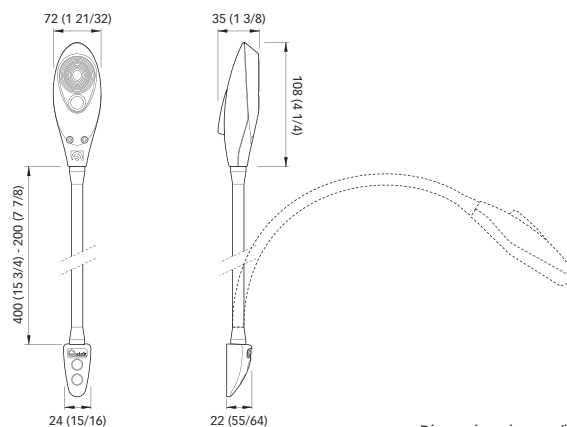

Dimensions in mm (inch)



## SHARK 30/50 - POWER LED - LED

LED CHART TABLE LIGHTS  
LUCI DA CARTEGGIO LED

Flexible  
READING LIGHT

IP40



Shark 30

With switch  
Con interruttore

## Light color / Colore Luce

● Bicolor: Cool White / Red  
Bicolore: Bianco Freddo / Rosso

## Materials / Materiali

● Head and base / Testa e base:  
composite material - Black color  
materiale composito - Colore nero



Shark 50

## YASMEEN - POWER LED

<b>Voltage system / Sistema</b>	<b>12 V / 24 V</b>
<b>Light source / Sorgente</b>	<b>POWER LED</b>
Operating voltage / Voltaggio	10 - 30 Vdc
<b>Power consumption / Potenza consumo</b>	<b>1,5 W</b>
Ampère consumption / Consumo Ampère	0,12 A @ 12 V / 0,06 A @ 24 V
LED protection / Protezione LED	Spike protected / Picchi di voltaggio $\pm$ 500 V
Polarity sensitive / Polarità	No

### Certifications / Certificazioni



### Dimensions / Dimensioni



20 mm (25/32 in)

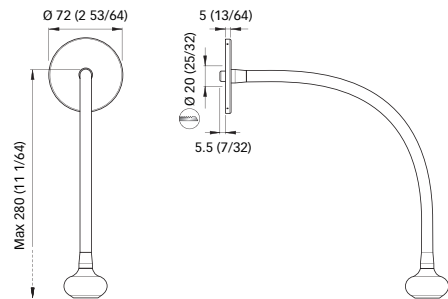

Dimensions in mm (inch)

Flexible  
READING LIGHT

IP40



Light color / Colore Luce  Warm White / Bianco Caldo

Materials / Materiali  Chromed brass  
Ottone cromato



## CHLOE - POWER LED

<b>Voltage system / Sistema</b>	<b>12 V / 24 V</b>
<b>Light source / Sorgente</b>	<b>POWER LED</b>
Operating voltage / Voltaggio	10 - 30 Vdc
<b>Power consumption / Potenza consumo</b>	<b>1,5 W</b>
Ampère consumption / Consumo Ampère	0,12 A @ 12 V / 0,06 A @ 24 V
LED protection / Protezione LED	Spike protected / Picchi di voltaggio $\pm$ 500 V
Polarity sensitive / Polarità	No

### Certifications / Certificazioni



### Dimensions / Dimensioni



20 mm (25/32 in)

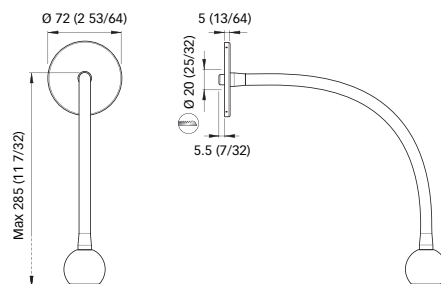

Dimensions in mm (inch)

## CHLOE - POWER LED

## LED READING LIGHTS LUCI DA LETTURA LED

3

Flexible  
READING LIGHT

IP40



Light color / Colore Luce  Warm White / Bianco Caldo

Materials / Materiali  Chromed brass  
Ottone cromato



## PETRA - POWER LED

<b>Voltage system / Sistema</b>	<b>12 V / 24 V</b>
<b>Light source / Sorgente</b>	<b>POWER LED</b>
Operating voltage / Voltaggio	10 - 30 Vdc
<b>Power consumption / Potenza consumo</b>	<b>1,5 W</b>
Ampère consumption / Consumo Ampère	0,12 A @ 12 V / 0,06 A @ 24 V
LED protection / Protezione LED	Spike protected / Picchi di voltaggio $\pm$ 500 V
Polarity sensitive / Polarità	No

### Certifications / Certificazioni



### Dimensions / Dimensioni



20 mm (25/32 in)

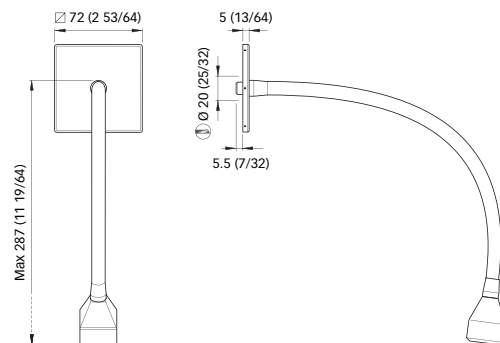

Dimensions in mm (inch)

Flexible  
READING LIGHT

IP40



Light color / Colore Luce  Warm White / Bianco Caldo

Materials / Materiali  Chromed brass  
Ottone cromato



## MAGDA - POWER LED

Voltage system / Sistema	12 V / 24 V
Light source / Sorgente	POWER LED
Operating voltage / Voltaggio	10 - 30 Vdc
Power consumption / Potenza consumo	1,5 W
Ampère consumption / Consumo Ampère	0,12 A @ 12 V / 0,06 A @ 24 V
LED protection / Protezione LED	Spike protected / Picchi di voltaggio $\pm$ 500 V
Polarity sensitive / Polarità	No

## Certifications / Certificazioni



## Dimensions / Dimensioni



20 mm (25/32 in)

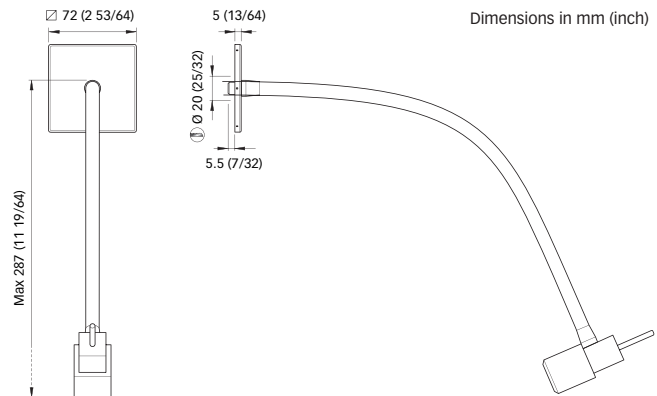

Flexible  
READING LIGHT

IP40



Light color / Colore Luce  Warm White / Bianco Caldo

Materials / Materiali  Chromed brass  
Ottone cromato



## LED COURTESY LIGHTS LUCI DI CORTESIA A LED

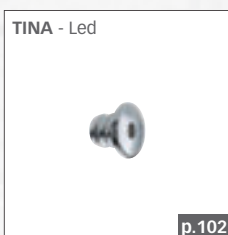

IP65 - Ø 20 / Recess 13



IP65 - Ø 40 / Recess 21

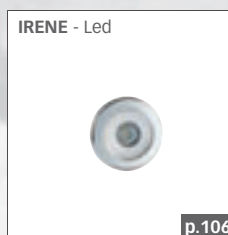

IP65 - Ø 45 / Recess 21

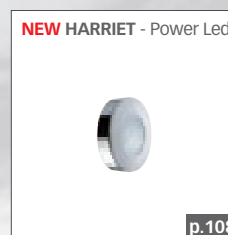

IP65 - Ø 44 / Recess 3

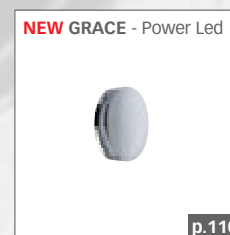

IP65 - Ø 44 / Recess 3

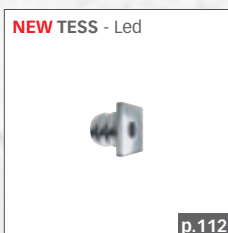

IP65 - Side 15 / Recess 13

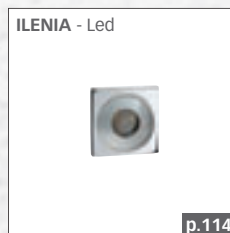

IP65 - Side 38 / Recess 21

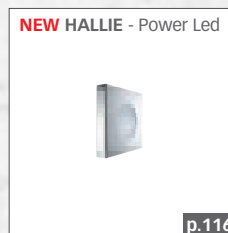

IP65 - Side 43 / Recess 3

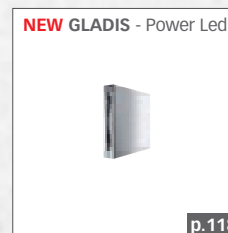

IP65 - Side 43 / Recess 3

IP40 = for interior applications only  
IP40 = solo per interni

IP65 = for interior and exterior applications  
IP65 = per interni ed esterni

Dimensions of diameter/maximum trim ring side length and recess are listed in mm  
Le dimensioni del diametro/lato max cornice e del recesso sono indicati in mm

# LED COURTESY LIGHTS

FOR EXTERIOR AND INTERIOR APPLICATIONS

LED COURTESY LIGHTS  
FOR EXTERIOR AND INTERIOR APPLICATIONS.  
TRIM RINGS IN AISI 316 STAINLESS STEEL.  
POWER LED AND LED LIGHT SOURCE.

LUCI DI CORTESIA PER ESTERNI ED INTERNI.  
CORNICI IN ACCIAIO INOX AISI 316.  
SORGENTE DI LUCE A POWER LED E LED.

<b>NEW</b>   GLADIS	p. 118
<b>NEW</b>   GRACE	p. 110
<b>NEW</b>   HARRIET	p. 108
<b>NEW</b>   HALLIE	p. 116
ILENIA	p. 114
IRENE	p. 106
PATRICIA	p. 104
<b>NEW</b>   TESS	p. 112
TINA	p. 102

## TINA - LED

Voltage system / Sistema	12 V / 24 V
Light source / Sorgente	LED
Operating voltage / Voltaggio	10 - 30 Vdc
Power consumption / Potenza consumo	0,24 W @ 12 V / 0,48 W @ 24 V
Ampère consumption / Consumo Ampère	0,02 A @ 12 V / 24 V
LED protection / Protezione LED	Spike protected / Picchi di voltaggio $\pm$ 500 V
Polarity sensitive / Polarità	No

## Certifications / Certificazioni



## Dimensions / Dimensioni

**13 mm** (1/2 in)

**20 mm** (25/32 in)

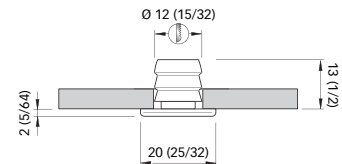
**12 mm** (15/32 in)

Dimensions in mm (inch)

**TINA - LED****LED COURTESY LIGHTS  
LUCI DI CORTESIA LED**

For exterior and interior applications / Per esterni ed interni

**Light color / Colore Luce**

- Daylight / Bianco Naturale
- Warm White / Bianco Caldo
- Blue / Blu
- Red / Rosso

**Material / Materiale****AISI 316 Stainless Steel / Acciaio Inox****Finishes / Finiture**

- Mirror polished / Inox lucido
- Satin / Satinato
- White 9010 / Bianco 9010

## PATRICIA - LED

Voltage system / Sistema	12 V / 24 V
Light source / Sorgente	LED
Operating voltage / Voltaggio	10 - 30 Vdc
Power consumption / Potenza consumo	0,24 W @ 12 V / 0,48 W @ 24 V
Ampère consumption / Consumo Ampère	0,02 A @ 12 V / 24 V
LED protection / Protezione LED	Spike protected / Picchi di voltaggio $\pm$ 500 V
Polarity sensitive / Polarità	No

### Certifications / Certificazioni



### Dimensions / Dimensioni

 21 mm (53/64 in)

 40 mm (37/64 in)

 19 mm (3/4 in)

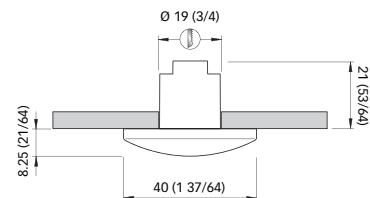

Dimensions in mm (inch)

## PATRICIA - LED

## LED COURTESY LIGHTS LUCI DI CORTESIA LED

For exterior and interior applications / Per esterni ed interni



### Light color / Colore Luce

- Daylight / Bianco Naturale
- Warm White / Bianco Caldo
- Blue / Blu
- Red / Rosso

### Material / Materiale

- Technopolymer
- UV stabilized
- Impact resistant
  
- Tecnopolimero
- Stabilizzato UV
- Resistente agli urti

## IRENE - LED

Voltage system / Sistema	12 V / 24 V
Light source / Sorgente	LED
Operating voltage / Voltaggio	10 - 30 Vdc
Power consumption / Potenza consumo	0,24 W @ 12 V / 0,48 W @ 24 V
Ampère consumption / Consumo Ampère	0,02 A @ 12 V / 24 V
LED protection / Protezione LED	Spike protected / Picchi di voltaggio $\pm$ 500 V
Polarity sensitive / Polarità	No

## Certifications / Certificazioni



## Dimensions / Dimensioni

 21 mm (53/64 in)

 45 mm (1 25/32 in)

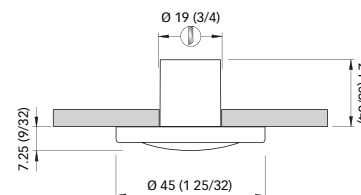
 19 mm (3/4 in)

Dimensions in mm (inch)

## IRENE - LED

LED COURTESY LIGHTS  
LUCI DI CORTESIA LED

For exterior and interior applications / Per esterni ed interni



## Light color / Colore Luce

- Daylight / Bianco Naturale
- Warm White / Bianco Caldo
- Blue / Blu
- Red / Rosso

## Material / Materiale

Trim ring : **AISI 316 stainless steel**  
 Lens : Technopolymer  
 - UV stabilized  
 - Impact resistant

Cornice : **Acciaio Inox AISI 316**  
 Lente : Tecnopolimero  
 - Stabilizzato UV  
 - Resistente agli urti

## Finishes / Finiture

- Mirror polished / Inox lucido
- Satin / Satinato
- White 9010 / Bianco 9010

## NEW | HARRIET - POWER LED



Voltage system / Sistema	12 V / 24 V
Light source / Sorgente	POWER LED
Operating voltage / Voltaggio	8 - 30 Vdc
Power consumption / Potenza consumo	1,5 W
Ampère consumption / Consumo Ampère	0,12 A @ 12 V / 0,06 A @ 24 V
LED protection / Protezione LED	Spike protected / Picchi di voltaggio $\pm$ 500 V
Polarity sensitive / Polarità	No

### Certifications / Certificazioni



### Dimensions / Dimensioni

 **3 mm** (7/64 in)

 **43 mm** (1 45/64 in)

 **25 mm** (63/64 in)

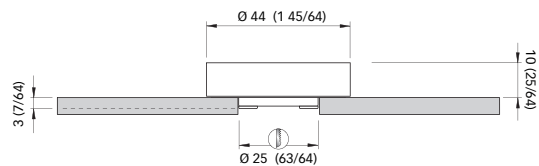

Dimensions in mm (inch)



**NEW | HARRIET**

**WALK OVER LED COURTESY LIGHTS  
LUCI DI CORTESIA LED CALPESTABILI**

For exterior and interior applications / Per esterni ed interni



**Light color / Colore Luce**

- Daylight / Bianco Naturale
- Warm White / Bianco Caldo
- Blue / Blu

**Material / Materiale**

**AISI 316 Stainless Steel / Acciaio Inox**

**Finishes / Finiture**

- Mirror polished / Inox lucido
- Satin / Satinato
- White 9010 / Bianco 9010



**NEW** | GRACE 1L/2L - POWER LED

Voltage system / Sistema	12 V / 24 V
Light source / Sorgente	POWER LED
Operating voltage / Voltaggio	8 - 30 Vdc
Power consumption / Potenza consumo	1,5 W
Ampère consumption / Consumo Ampère	0,12 A @ 12 V / 0,06 A @ 24 V
LED protection / Protezione LED	Spike protected / Picchi di voltaggio $\pm$ 500 V
Polarity sensitive / Polarità	No

**Certifications / Certificazioni****Dimensions / Dimensioni**

**3 mm** (7/64 in)

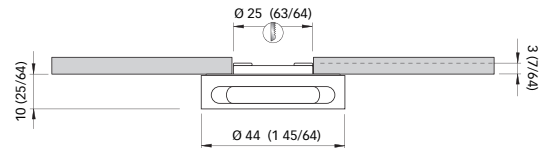
**43 mm** (1 45/64 in)



**25 mm** (63/64 in)

Dimensions in mm (inch)

**NEW** | GRACE 1L/2L - POWER LED

**LED COURTESY LIGHTS  
LUCI DI CORTESIA LED**

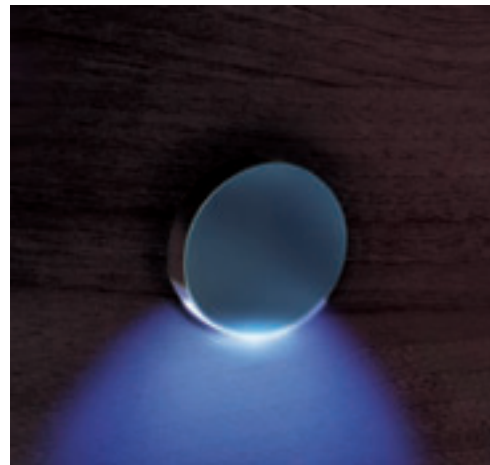
For exterior and interior applications / Per esterni ed interni





GRACE 1L



GRACE 2L

- Light color / Colore Luce**
-  Daylight / Bianco Naturale
  -  Warm White / Bianco Caldo
  -  Blue / Blu

**Material / Materiale** AISI 316 Stainless Steel / Acciaio Inox

- Finishes / Finiture**
-  Mirror polished / Inox lucido
  -  Satin / Satinato
  -  White 9010 / Bianco 9010



Voltage system / Sistema	12 V / 24 V
Light source / Sorgente	LED
Operating voltage / Voltaggio	10 - 30 Vdc
Power consumption / Potenza consumo	1,24 W @ 12 V / 0,48 W @ 24 V
Ampère consumption / Consumo Ampère	0,02 A @ 12 V / 24 V
LED protection / Protezione LED	Spike protected / Picchi di voltaggio $\pm$ 500 V
Polarity sensitive / Polarità	No

#### Certifications / Certificazioni



#### Dimensions / Dimensioni

 13 mm (1/2 in)

 15 mm (5/8 in)

 12 mm (15/32 in)

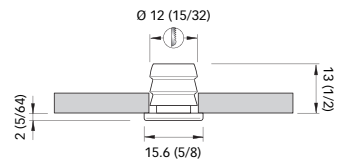

Dimensions in mm (inch)

**NEW** | TESS - LED**LED COURTESY LIGHTS  
LUCI DI CORTESIA LED**

For exterior and interior applications / Per esterni ed interni

**Light color / Colore Luce**

- Daylight / Bianco Naturale
- Warm White / Bianco Caldo
- Blue / Blu
- Red / Rosso

**Material / Materiale****AISI 316 Stainless Steel / Acciaio Inox****Finishes / Finiture**

- Mirror polished / Inox lucido
- Satin / Satinato
- White 9010 / Bianco 9010

## ILENIA - LED

Voltage system / Sistema	12 V / 24 V
Light source / Sorgente	LED
Operating voltage / Voltaggio	10 - 30 Vdc
Power consumption / Potenza consumo	0,24 W @ 12 V / 0,48 W @ 24 V
Ampère consumption / Consumo Ampère	0,02 A @ 12 V / 24 V
LED protection / Protezione LED	Spike protected / Picchi di voltaggio $\pm$ 500 V
Polarity sensitive / Polarità	No

## Certifications / Certificazioni



## Dimensions / Dimensioni

 21 mm (53/64 in)

 38 mm (1 15/32 in)

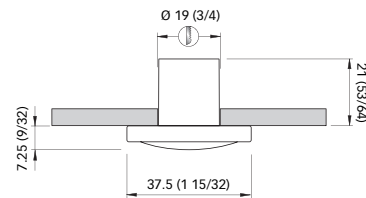
 19 mm (3/4 in)

Dimensions in mm (inch)

## ILENIA - LED

LED COURTESY LIGHTS  
LUCI DI CORTESIA LED

For exterior and interior applications / Per esterni ed interni



## Light color / Colore Luce

- Daylight / Bianco Naturale
- Warm White / Bianco Caldo
- Blue / Blu
- Red / Rosso

## Material / Materiale

Trim ring : **AISI 316 stainless steel**  
 Lens : Technopolymer  
 - UV stabilized  
 - Impact resistant

Cornice : **Acciaio Inox AISI 316**  
 Lente : Tecnopolimero  
 - Stabilizzato UV  
 - Resistente agli urti

## Finishes / Finiture

- Mirror polished / Inox lucido
- Satin / Satinato
- White 9010 / Bianco 9010

**NEW** | HALLIE - POWER LED

Voltage system / Sistema	12 V / 24 V
Light source / Sorgente	POWER LED
Operating voltage / Voltaggio	8 - 30 Vdc
Power consumption / Potenza consumo	1,5 W
Ampère consumption / Consumo Ampère	0,12 A @ 12 V / 0,06 A @ 24 V
LED protection / Protezione LED	Spike protected / Picchi di voltaggio $\pm$ 500 V
Polarity sensitive / Polarità	No

**Certifications / Certificazioni****Dimensions / Dimensioni**

**3 mm** (7/64 in)

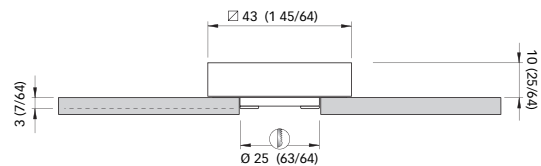
**43 mm** (1 45/64 in)

**25 mm** (63/64 in)

Dimensions in mm (inch)



**NEW | HALLIE****WALK OVER LED COURTESY LIGHTS  
LUCI DI CORTESIA LED CALPESTABILI**

For exterior and interior applications / Per esterni ed interni

**Light color / Colore Luce**

- Daylight / Bianco Naturale
- Warm White / Bianco Caldo
- Blue / Blu

**Material / Materiale****AISI 316 Stainless Steel / Acciaio Inox****Finishes / Finiture**

- Mirror polished / Inox lucido
- Satin / Satinato
- White 9010 / Bianco 9010



**NEW** | GLADIS 1L/2L - POWER LED

Voltage system / Sistema	12 V / 24 V
Light source / Sorgente	POWER LED
Operating voltage / Voltaggio	8 - 30 Vdc
Power consumption / Potenza consumo	1,5 W
Ampère consumption / Consumo Ampère	0,12 A @ 12 V / 0,06 A @ 24 V
LED protection / Protezione LED	Spike protected / Picchi di voltaggio $\pm$ 500 V
Polarity sensitive / Polarità	No

**Certifications / Certificazioni****Dimensions / Dimensioni**

**3 mm** (7/64 in)

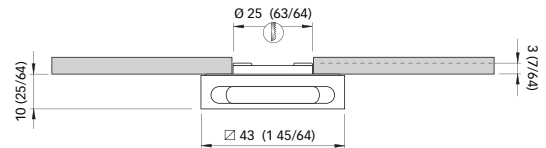
**43 mm** (1 45/64 in)



**25 mm** (63/64 in)

Dimensions in mm (inch)

**NEW** | GLADIS 1L/2L - POWER LED

**LED COURTESY LIGHTS  
LUCI DI CORTESIA LED**

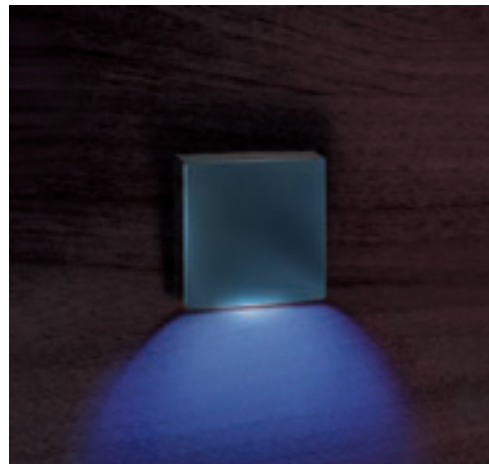
For exterior and interior applications / Per esterni ed interni



GLADIS 1L



GLADIS 2L

- Light color / Colore Luce**
- Daylight / Bianco Naturale
  - Warm White / Bianco Caldo
  - Blue / Blu

**Material / Materiale** AISI 316 Stainless Steel / Acciaio Inox

- Finishes / Finiture**
- Mirror polished / Inox lucido
  - Satin / Satinato
  - White 9010 / Bianco 9010



# LED LIGHTING

## LED LIGHT BARS PROFILI LED

**NEW SYRIA** - Led



p.122

**IP40** - Adjustable

**NEW MODULAR 2D** - Led



p.124

**IP40** - Modular system

**NEW MODULAR 2D** - Led



p.126

**IP40** - Modular system

IP40 = For interiors  
IP40 = Per interni



**QUICK MARINE LIGHTING**

# LED LIGHT BARS

FOR INTERIORS

LED LIGHT BARS FOR INTERIORS.  
SURFACE MOUNT.

PROFILI LED PER INTERNI.  
MONTAGGIO IN SUPERFICIE

## NEW | SYRIA 15/28/41 - LED

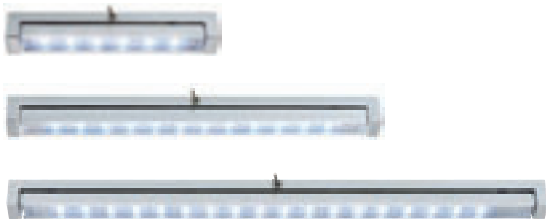

Model / Modello	Syria 15		Syria 28		Syria 41	
Voltage system / Sistema	12 V	24 V	12 V	24 V	12 V	24 V
Light source / Sorgente	LED		LED		LED	
Operating voltage / Voltaggio	10 - 15 Vdc	20 - 30 Vdc	10 - 15 Vdc	20 - 30 Vdc	10 - 15 Vdc	20 - 30 Vdc
Power consumption / Potenza consumo	1,5 W		3 W		4,5 W	
Ampère consumption / Consumo Ampère	0,12 A	0,06 A	0,24 A	0,12 A	0,36 A	0,18 A
LED protection / Protezione LED	Spike protected / Picchi di voltaggio $\pm$ 500 V					
Polarity sensitive / Polarità	Yes / Sì					

### Certifications / Certificazioni



### Dimensions / Dimensioni

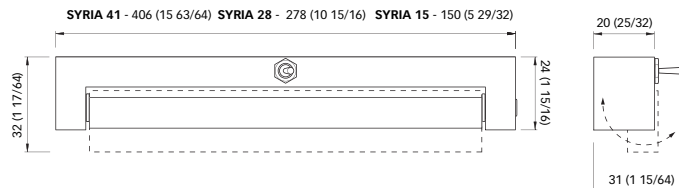

Dimensions in mm (inch)



**Light color / Colore Luce**

- Cool White / Bianco Freddo
- Warm White / Bianco Caldo

**Material / Materiale**

- Chromed aluminium  
Alluminio cromato
- Opaque anodized aluminum  
Alluminio anodizzato opaco



## NEW | MODULAR 2D - 30/50/100 - LED

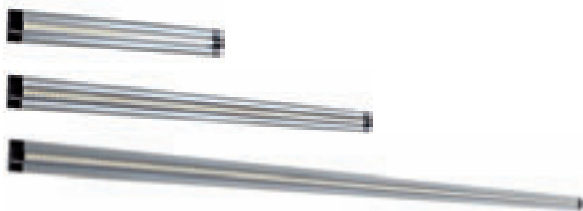

Model / Modello	Modular 2D - 30		Modular 2D - 50		Modular 2D - 100	
	12 V	24 V	12 V	24 V	12 V	24 V
Voltage system / Sistema	12 V	24 V	12 V	24 V	12 V	24 V
Light source / Sorgente	LED		LED		LED	
Operating voltage / Voltaggio	10 - 15 Vdc	20 - 30 Vdc	10 - 15 Vdc	20 - 30 Vdc	10 - 15 Vdc	20 - 30 Vdc
Power consumption / Potenza consumo	3 W		5 W		10 W	
Ampère consumption / Consumo Ampère	0,25 A @ 12 V 0,42 A @ 15 V	0,13 A @ 24 V 0,21 A @ 30 V	0,42 A @ 12 V 0,7 A @ 15 V	0,21 A @ 24 V 0,35 A @ 30 V	0,84 A @ 12 V 1,4 A @ 15 V	,42 A @ 24 V 0,7 A @ 30 V
LED protection / Protezione LED	Spike protected / Picchi di voltaggio $\pm$ 500 V					
Polarity sensitive / Polarità	Yes / Sì					

### Certifications / Certificazioni



### Dimensions / Dimensioni

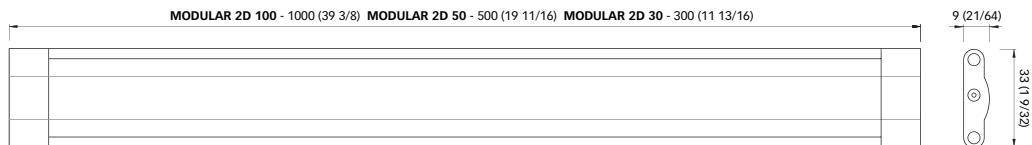

Dimensions in mm (inch)

IP40



**Light color / Colore Luce** ● Warm White / Bianco Caldo

**Material / Materiale** ● Anodized aluminum  
Alluminio anodizzato

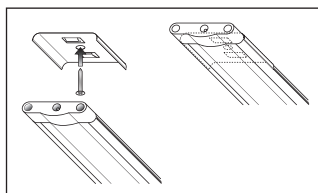

Staffe di fissaggio  
incluse nella confezione.  
Mounting brackets  
included in the package.

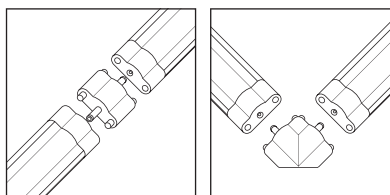

Su richiesta i giunti per  
l'assemblaggio  
lineare o angolare dei moduli.  
Joints for linear or corner  
mounting are available  
on request.

## NEW | MODULAR 3D - 30/50/100 - LED



Model / Modello	Modular 3D - 30		Modular 3D - 50		Modular 3D - 100	
	12 V	24 V	12 V	24 V	12 V	24 V
Voltage system / Sistema	12 V	24 V	12 V	24 V	12 V	24 V
Light source / Sorgente	LED		LED		LED	
Operating voltage / Voltaggio	10 - 15 Vdc	20 - 30 Vdc	10 - 15 Vdc	20 - 30 Vdc	10 - 15 Vdc	20 - 30 Vdc
Power consumption / Potenza consumo	3 W		5 W		10 W	
Ampère consumption / Consumo Ampère	0,25 A @ 12 V 0,42 A @ 15 V	0,13 A @ 24 V 0,21 A @ 30 V	0,42 A @ 12 V 0,7 A @ 15 V	0,21 A @ 24 V 0,35 A @ 30 V	0,84 A @ 12 V 1,4 A @ 15 V	0,42 A @ 24 V 0,7 A @ 30 V
LED protection / Protezione LED	Spike protected / Picchi di voltaggio $\pm$ 500 V					
Polarity sensitive / Polarità	Yes / Sì					

### Certifications / Certificazioni



### Dimensions / Dimensioni

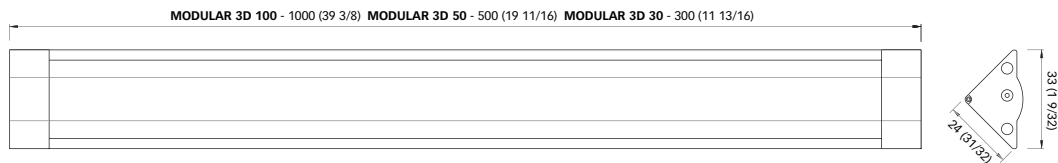

Dimensions in mm (inch)

IP40



**Light color / Colore Luce** ● Warm White / Bianco Caldo

**Material / Materiale** ● Anodized aluminum  
Alluminio anodizzato

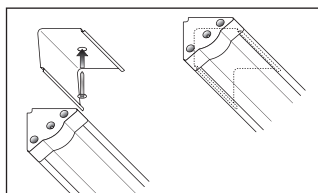

Staffe di fissaggio  
incluse nella confezione.  
Mounting brackets  
included in the package.

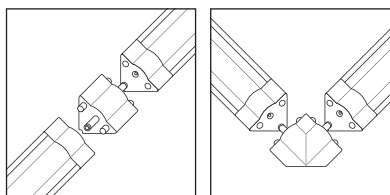

Su richiesta i giunti per  
l'assemblaggio  
lineare o angolare dei moduli.  
Joints for linear or corner  
mounting are available  
on request.

## LED INDIRECT LIGHTS LUCI INDIRETTE A LED

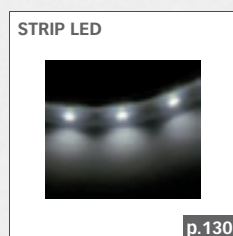

IP67 - Daylight

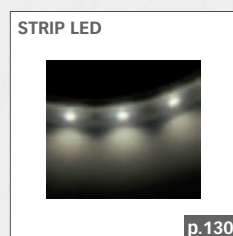

IP67 - Warm white

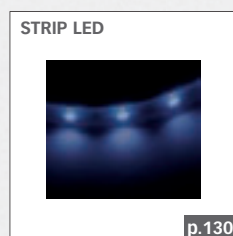

IP67 - Blue

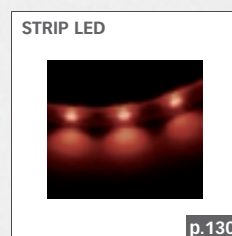

IP67 - Red

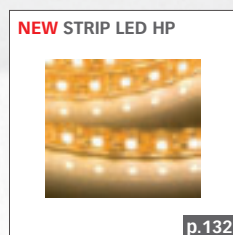

IP67 - Warm white

IP67 = watertight for exterior applications  
IP67 = impermeabile per esterni

# LED INDIRECT LIGHTS

INDIRECT LIGHTS.  
ADJUSTABLE.  
LED OR POWER LED LIGHT SOURCE.

LUCE INDIRETTA.  
FLESSIBILI.  
SORGENTE DI LUCE A LED o POWER LED.

## STRIP LED

Voltage system / Sistema	12 V	24 V
Light source / Sorgente	LED	
Operating voltage / Voltaggio	10 - 15 Vdc	20 - 30 Vdc
Power consumption / Potenza consumo	<b>4,8 W/m @ 12 V</b>	<b>4,8 W/m @ 24 V</b>
Ampère consumption / Consumo Ampère	0,4 A/m @ 12 V 0,6 A/m @ 15 V	0,2 A/m @ 24 V 0,3 A/m @ 30 V
LED protection / Protezione LED	Spike protected / Picchi di voltaggio $\pm$ 500 V	
Polarity sensitive / Polarità	Yes / Sì	

## Certifications / Certificazioni



## Dimensions / Dimensioni

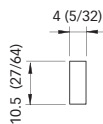

Dimensions in mm (inch)

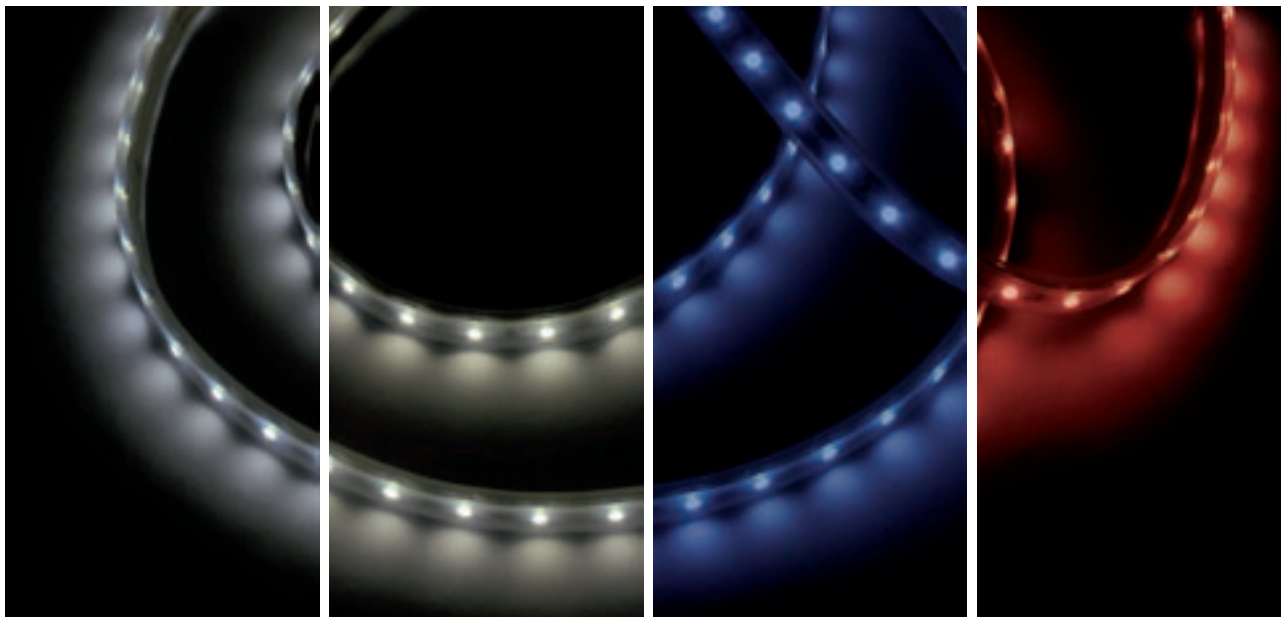

## STRIP LED

LED INDIRECT LIGHT  
LUCE INDIRETTA A LED

## Light color / Colore Luce

- Daylight / Bianco Naturale
- Warm White / Bianco Caldo
- Blue / Blu\*
- Red / Rosso\*

## Materials / Materiali

Sheath in UV-resistant silicone.  
Guaina in silicone resistente UV.

## Silicone Clip



## Mounting kit / Kit per il montaggio



**Strip Led** is supplied with fixing clips for installation.  
The **kits** including **clips, driver and caps** are available on demand in order to adjust at will the length of the Strip Led.

**Strip Led** è fornita completa di clip per il montaggio.  
Su richiesta sono disponibili anche i **Kit** che includono **clip, driver e cap** per modificare a piacere la lunghezza della Strip Led.

\* Only for 24 volt system / Solo per sistema 24 volt

**NEW | STRIP LED HP**

Voltage system / Sistema	12 V	24 V
Light source / Sorgente	POWER LED	
Operating voltage / Voltaggio	10 - 15 Vdc	20 - 30 Vdc
Power consumption / Potenza consumo	14,4 W/m @ 12 V	14,4 W/m @ 24 V
Ampère consumption / Consumo Ampère	1,2 A/m @ 12 V 1,8 A/m @ 15 V	0,6 A/m @ 24 V 0,9 A/m @ 30 V
LED protection / Protezione LED	Spike protected / Picchi di voltaggio $\pm$ 500 V	
Polarity sensitive / Polarità	Yes / Sì	

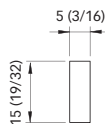
**Certifications / Certificazioni****Dimensions / Dimensioni**

Dimensions in mm (inch)





Light color / Colore Luce  Warm White / Bianco Caldo

Materials / Materiali UV-resistant epoxide resin.  
Resina epossidica resistente UV.

Silicone Clip



**Strip Led HP** is supplied with bi-adhesive tape and silicone fixing clips for installation.

**Strip Led HP** è fornita completa di bi-adesivo e clip in silicone per il montaggio.

## UTILITY LED LIGHTS LUCI DI UTILITA' A LED

SECRET LIGHT - Led



p.136

IP66 - Retractable

KIRK - Led



p.138

IP40 - Ø 135

IP40 = for interior applications only  
IP40 = solo per interni

IP66 = for interior and exterior applications  
IP66 = per interni ed esterni

Dimensions of diameter/maximum trim ring side length and recess are listed in mm  
Le dimensioni del diametro/lato max cornice e del recesso sono indicati in mm

# UTILITY LED LIGHTS

FOR EXTERIOR AND INTERIOR APPLICATIONS

UTILITY LIGHTS FOR EXTERIOR AND INTERIOR APPLICATIONS.  
LED LIGHT SOURCE.

LUCI DI UTILITÀ PER ESTERNI ED INTERNI.  
SORGENTE DI LUCE A LED.

MODELS IN ALPHABETICAL ORDER

**KIRK** p. 138  
**NEW | SECRET LIGHT** p. 136

**NEW** | SECRET LIGHT - LED

Voltage system / Sistema	12 V / 24 V
Light source / Sorgente	36 LED - High Luminosity / Alta Luminosità
Operating voltage / Voltaggio	10 - 30 Vdc
Power consumption / Potenza consumo	9 W
Ampère consumption / Consumo Ampère	0,75A @ 12 V / 0,38 A @ 24 V
LED protection / Protezione LED	Spike protected / Picchi di voltaggio $\pm$ 500 V
Polarity sensitive / Polarità	Si/Yes

## Certifications / Certificazioni

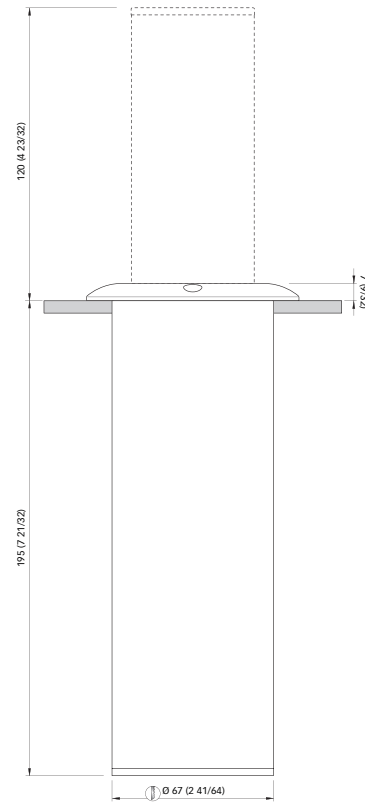
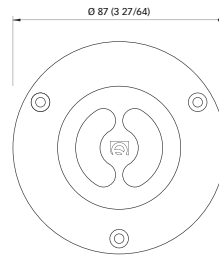

## Dimensions / Dimensioni



Dimensions in mm (inch)



**NEW | SECRET LIGHT - LED****LED UTILITY LIGHTS  
LUCI DI UTILITÀ A LED****SECRET LIGHT IS AN LED RETRACTABLE DECK LAMP.**

SECRET LIGHT is an LED light consisting of an illuminating cylinder that can be pushed into its housing and disappear completely. In this case, the light is turned off and a bayonet mechanism locks it in place. To extract it, the user simply gives the cylinder a gentle push to release a spring which pushes it back out. The light turns on automatically when the cylinder reaches its position.

**SECRET LIGHT È UNA LAMPADA LED A SCOMPARSA.**

Secret Light è un apparecchio d'illuminazione a LED costituito da un cilindro luminoso che può essere spinto all'interno dell'apposita sede e scomparire completamente. In questa situazione la luce è spenta ed un meccanismo a baionetta garantisce il fissaggio. L'estrazione richiede un semplice gesto per sbloccare il cilindro che spinto da una molla si apre senza ulteriori manovre per l'utente. La luce si accende automaticamente quando il cilindro raggiunge la sua posizione.



**Light color / Colore Luce** ● Warm White / Bianco Caldo

**Material / Materiale** AISI 316 Stainless Steel / Acciaio Inox

**Finishes / Finiture** ● Mirror polished / Inox lucido

## KIRK - LED



Light source / Sorgente	48 LED 5 mm
Power supply / Alimentazione	3 batteries / 3 batterie AA 1,5V (not included / non include)

## Certifications / Certificazioni



## Dimensions / Dimensioni

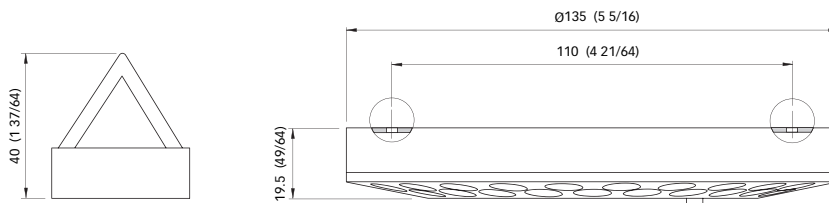

Dimensions in mm (inch)



IP40



Light color / Colore Luce  Cool White / Bianco Freddo

Finishes / Finiture  Silver grey / Grigio argento

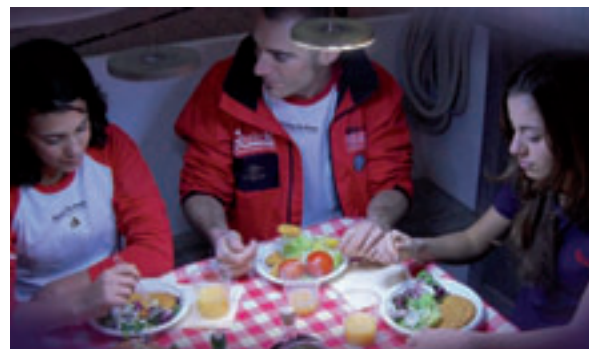

## LED UNDERWATER LIGHT LUCE SUBACQUEA A LED



IP68 - Through-Hull

IP68 = watertight  
IP68 = Stagno

| Dimensions of diameter/maximum trim ring side length and recess are listed in mm  
| Le dimensioni del diametro/lato max cornice e del recesso sono indicati in mm



QUICK MARINE LIGHTING

# LED UNDERWATER LIGHT

LED LIGHT FOR UNDERWATER APPLICATIONS (IP68).  
POWER LED LIGHT SOURCE.

LUCI PER INSTALLAZIONI SUBACQUEE (IP68).  
SORGENTE DI LUCE A POWER LED.



## XYPER 18

<b>Voltage system / Sistema</b>	<b>12 V / 24 V</b>
<b>Light source / Sorgente</b>	<b>POWER LED 18 W</b>
Operating voltage / Voltaggio	10 - 30 Vdc
<b>Power consumption / Potenza consumo</b>	<b>18 W</b>
Ampère consumption / Consumo Ampère	1,5 A @ 12 V / 750 mA @ 24 V
LED protection / Protezione LED	Against inversion of polarity / Contro l'inversione di polarità
	Spike protected / Picchi di voltaggio $\pm$ 500 V
Light emission / Illuminamento	1000 Lumen
Beam angle / Angolo d'apertura	90°

### Certifications / Certificazioni



### Dimensions / Dimensioni

	<b>92 mm</b> (3 5/8 in)
	<b>76 mm</b> (3 in)
	<b>51 mm</b> (2 in)

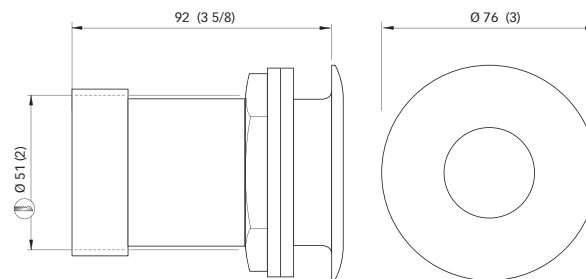

Dimensions in mm (inch)



**Light color / Colore Luce** ● Cool White / Bianco Freddo

**Materials / Materiali** ● Through-Hull connection - FRP  
Passascafo - FRP

**Installation / Installazione**

- Through-Hull
- Light emitter pre-wired with 4 m cable
- Power box IP67 on cable
- Passascafo
- Precablato con cavo di 4 m.
- Scatola di alimentazione IP67 sul cavo



## LED BULBS LAMPADINE A LED

ZELIG BE



p.146

**IP40** - Back entry  
For 12/24 V System

ZELIG SE



p.148

**IP40** - Side entry  
For 12 V System

ZELIG SE



p.148

**IP40** - Side entry  
For 24 V System

IP40 = for interior applications only  
IP40 = solo per interni

IP65 = for interior and exterior applications  
IP65 = per interni ed esterni

Dimensions of diameter/maximum trim ring side length and recess are listed in mm  
Le dimensioni del diametro/lato max cornice e del recesso sono indicati in m



QUICK MARINE LIGHTING

# LED BULBS

LED REPLACEMENT BULBS FOR 12/24 V SYSTEM  
LAMPADINE LED PER SISTEMI A 12/24 V

<b>ZELIG BE</b>	p. 146
<b>ZELIG SE</b> (For 12 V system)	p. 148
<b>ZELIG SE</b> (For 24 V system)	p. 148

## ZELIG BACK ENTRY - G4



Voltage system / Sistema	12 V / 24 V
Socket / Portalamпада	G4 - Back Entry / G4 - Attacco Posteriore
Light source / Sorgente	POWER LED
Operating voltage / Voltaggio	10 - 30 Vdc
Power consumption / Potenza consumo	1,5 W
Ampère consumption / Consumo Ampère	0,12 A @ 12 V / 0,06 mA @ 24 V
LED protection / Protezione LED	Spike protected / Picchi di voltaggio $\pm$ 500 V
Polarity sensitive / Polarità	No

## Certifications / Certificazioni



Light color / Colore Luce

- Daylight / Bianco Naturale
- Warm White / Bianco Caldo

## Dimensions / Dimensioni

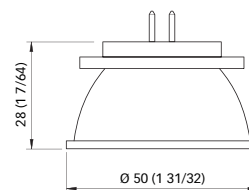

Dimensions in mm (inch)

IP40

## ZELIG LED G4 SUITABLE FOR SHALLOW RECESS DOWNLIGHT INSTALLATIONS.

Changing your lighting system with ZELIG LED is quick and easy! Just remove the reflector from the downlight and put in the Zelig LED G4.

ZELIG LED replicates the lighting capacity of a 10W G4 halogen bulb but with a power consumption of only 1,5 W

## ZELIG LED G4 È INSTALLABILE SUI FARETTI A BASSO INCASSO.

Cambiare il sistema d'illuminazione con Zelig LED è rapido e facile! E' sufficiente rimuovere il riflettore da ogni faretto e inserire ZELIG LED G4

ZELIG LED replica la capacità di illuminazione di un'alogena G4 da 10 W con un consumo di soli 1,5 W.

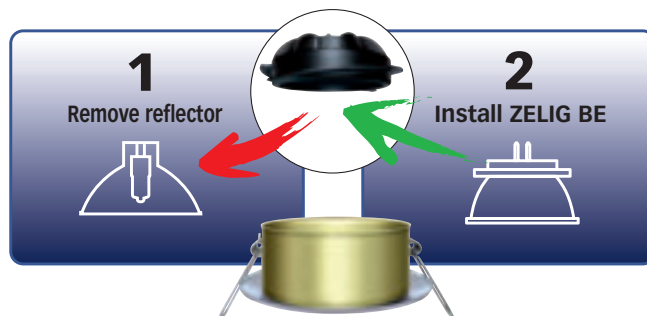

## ZELIG SIDE ENTRY - G4



Voltage system / Sistema	12 V	24 V
Socket / Portalampada	G4 - Side Entry / G4 - Attacco Laterale	
Light source / Sorgente	27 LED - High Luminosity 27 LED - Alta Luminosità	24 LED - High Luminosity 24 LED - Alta Luminosità
Operating voltage / Voltaggio	10 - 15 Vdc	10 - 30 Vdc
Power consumption / Potenza consumo	2,2 W	2,2 W
Ampère consumption / Consumo Ampère	0,18 A	0,09 A
LED protection / Protezione LED	Spike protected / Picchi di voltaggio $\pm$ 500 V	
Polarity sensitive / Polarità	No	

## Certifications / Certificazioni



- Light color / Colore Luce**
- 12 V**
- Daylight / Bianco Naturale
  - Warm White / Bianco Caldo
  - Cool White / Bianco Freddo
  - Red / Rosso
- 24 V**
- Daylight / Bianco Naturale
  - Warm White / Bianco Caldo

## Dimensions / Dimensioni

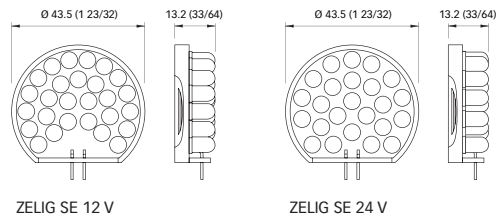

Dimensions in mm (inch)

IP40

## ZELIG LED G4 SUITABLE FOR SHALLOW RECESS DOWNLIGHT INSTALLATIONS.

Changing your lighting system with ZELIG LED is quick and easy! Just remove the reflector from the downlight and put in the Zelig LED G4.

ZELIG LED replicates the lighting capacity of a 10W G4 halogen bulb but with a power consumption of only 2.2W

## ZELIG LED G4 È INSTALLABILE SU TUTTI I FARETTI A BASSO INCASSO.

Cambiare il sistema d'illuminazione con Zelig LED è rapido e facile! E' sufficiente rimuovere il riflettore da ogni faretto e inserire ZELIG LED G4

ZELIG LED replica la capacità di illuminazione di un'alogena G4 da 10 W con un consumo di soli 2,2 W.

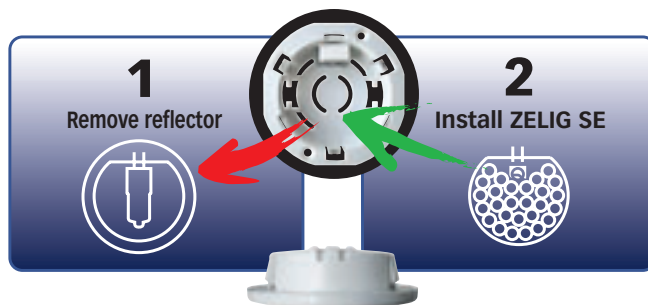



**HALOGEN LIGHTING**

**RECESSED HALOGEN DOWNLIGHTS**

**10**

**HALOGEN SURFACE-MOUNT FIXTURES**

**11**

**HALOGEN READING LIGHTS**

**12**

**HALOGEN BULBS**

**13**

# HALOGEN LIGHTING

# RECESSED HALOGEN DOWNLIGHTS

FOR EXTERIOR AND INTERIOR APPLICATIONS

RECESSED DOWNLIGHTS  
FOR EXTERIOR AND INTERIOR APPLICATIONS.  
TRIM RINGS IN AISI 316 STAINLESS STEEL.  
HALOGEN LIGHT SOURCE.

FARETTI AD INCASSO PER ESTERNI ED INTERNI.  
CORNICI IN ACCIAIO INOX AISI 316.  
SORGENTE DI LUCE ALOGENA

MODELS IN ALPHABETICAL ORDER

<b>ALEX</b>	p. 166
<b>ANDREAS</b>	p. 174
<b>BERNARD</b>	p. 188
<b>BORIS</b>	p. 172
<b>CARMEN</b>	p. 184
<b>EDGAR</b>	p. 186
<b>ELISABETH</b>	p. 176
<b>GIULIA</b>	p. 178
<b>LARA</b>	p. 192
<b>LAWRENCE</b>	p. 168
<b>LISA</b>	p. 190
<b>LUCREZIA</b>	p. 170
<b>MINA</b>	p. 162
<b>OLAF</b>	p. 160
<b>SABINE</b>	p. 164
<b>SILVIA</b>	p. 180
<b>TEO</b>	p. 156
<b>TEO S</b>	p. 158
<b>TOSCA</b>	p. 182

## RECESSED HALOGEN DOWNLIGHTS FOR EXTERIOR AND INTERIOR APPLICATIONS

### FARETTI ALOGENI AD INCASSO PER ESTERNI ED INTERNI



IP40 - Ø 72 / Recess 17



IP40 - Ø 72 / Recess 17



IP40 - Ø 72 / Recess 17

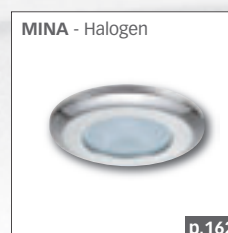

IP40 - Ø 77 / Recess 16



IP40 - Ø 77 / Recess 16



IP65 - Ø 80 / Recess 24



IP65 - Ø 80 / Recess 41



IP40 - Ø 80 / Recess 35



IP65 - Ø 80 / Recess 22



IP65 - Ø 80 / Recess 39

IP40 = for interior applications only  
IP40 = solo per interni

IP65 = for interior and exterior applications  
IP65 = per interni ed esterni

Dimensions of diameter/maximum trim ring side length and recess are listed in mm  
Le dimensioni del diametro/lato max cornice e del recesso sono indicati in mm



IP40 - Ø 80 / Recess 33



IP65 - Ø 87 / Recess 23



IP65 - Ø 105 / Recess 24



IP65 - Ø 155 / Recess 25



IP65 - Ø 155 / Recess 25



IP40 - Side 72 / Recess 17



IP40 - Side 72 / Recess 17



IP65 - Side 72 / Recess 24



IP65 - Side 72 / Recess 39

IP40 = for interiors only | IP65 = for interiors and exteriors | Dimensions of diameter/maximum trim ring side length and recess are listed in mm  
 IP40 = solo per interni | IP65 = per interni ed esterni | Le dimensioni del diametro/lato max cornice e del recesso sono indicati in mm

## TEO



Socket / Portalamпада	G4
Operating voltage / Voltaggio	12/24 V
Max power / Max potenza	10 W

Beam 40° / Angolo 40°

Distance / Distanza

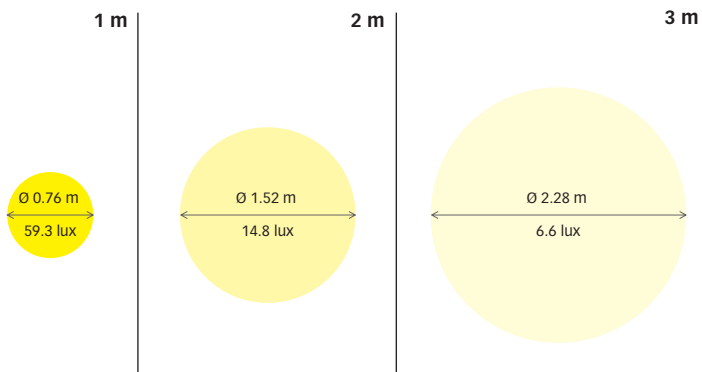
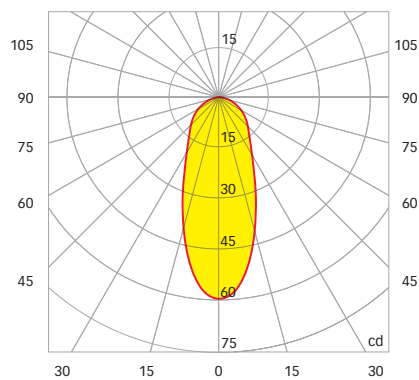

Certifications / Certificazioni



TEO

RECESSED HALOGEN DOWNLIGHTS  
FARETTI ALOGENI AD INCASSO

Per interni / For interiors

IP40 72 17





## Material / Materiale

AISI 316 Stainless Steel / Acciaio Inox

## Finishes / Finiture

-  Mirror polished / Inox lucido
-  Satin / Satinato
-  White 9010 / Bianco 9010
-  Gold / Oro **PVD**
-  Bronze / Bronzo **PVD**
-  Black Nickel / Nichel Nero **PVD**

## Dimensions / Dimensioni

-  17 mm (43/64 in)
-  72 mm (2 53/64 in)
-  54 mm (2 1/8 in)

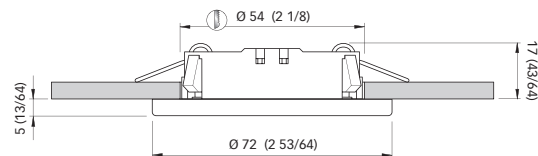

Dimensions in mm (inch)

## TEO S



Socket / Portalampada	G4
Operating voltage / Voltaggio	12/24 V
Max power / Max potenza	10 W

Beam 40° / Angolo 40°

Distance / Distanza

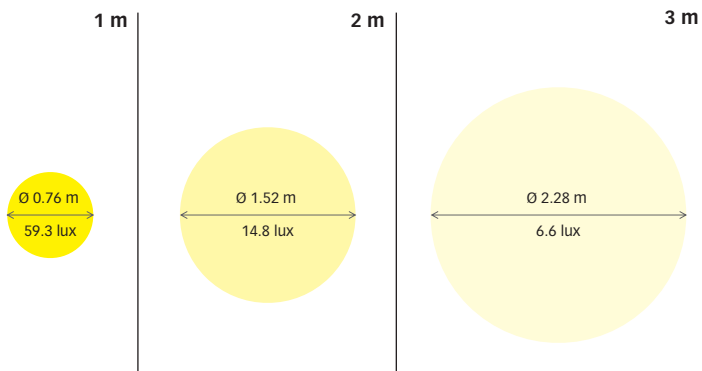
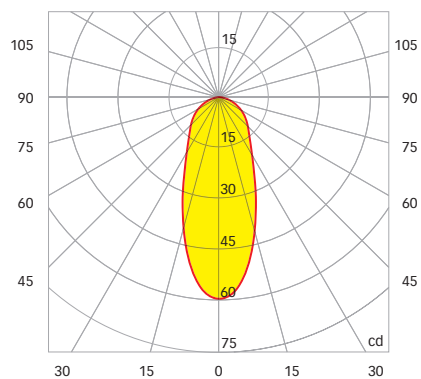

Certifications / Certificazioni



## TEO S

RECESSED HALOGEN DOWNLIGHTS  
FARETTI ALOGENI AD INCASSO

Per interni / For interiors



IP40 72 17

Con interruttore  
With switch



## Material / Materiale

AISI 316 Stainless Steel / Acciaio Inox

## Finishes / Finiture\*

-  Mirror polished / Inox lucido
-  Satin / Satinato
-  White 9010 / Bianco 9010

## Dimensions / Dimensioni

-  17 mm (43/64 in)
-  72 mm (2 53/64 in)
-  54 mm (2 1/8 in)

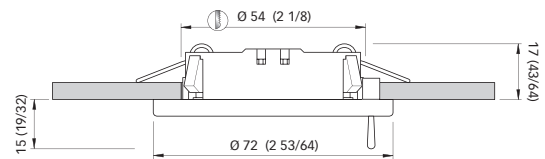

Dimensions in mm (inch)

\*Other finishes available upon request / Altre finiture su richiesta

## OLAF



Socket / Portalampada	<b>G4</b>
Operating voltage / Voltaggio	12/24 V
Max power / Max potenza	<b>10 W</b>

Beam 40° / Angolo 40°

Distance / Distanza

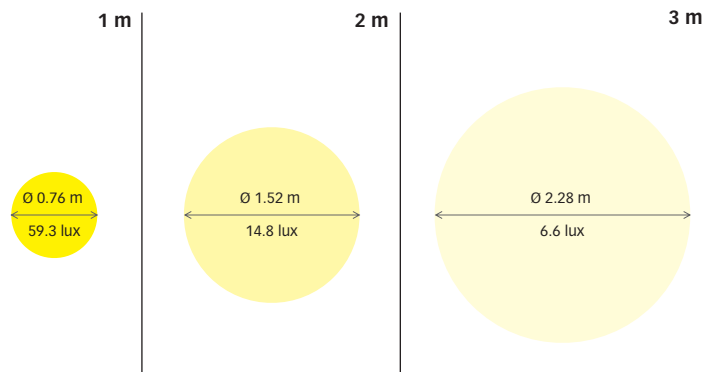
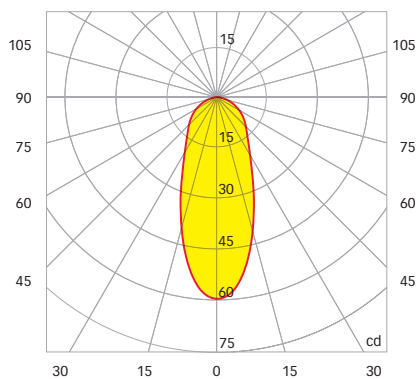

Certifications / Certificazioni



## OLAF

RECESSED HALOGEN DOWNLIGHTS  
FARETTI ALOGENI AD INCASSO

Per interni / For interiors



IP40 72 17





## Material / Materiale

AISI 316 Stainless Steel / Acciaio Inox

## Finishes / Finiture\*

-  Mirror polished / Inox lucido
-  Satin / Satinato
-  White 9010 / Bianco 9010

## Dimensions / Dimensioni

-  17 mm (43/64 in)
-  72 mm (2 53/64 in)
-  54 mm (2 1/8 in)

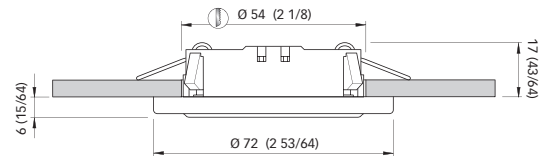

\*Other finishes available upon request / Altre finiture su richiesta

Dimensions in mm (inch)

## MINA



Socket / Portalampada	<b>G4</b>
Operating voltage / Voltaggio	12/24 V
Max power / Max potenza	<b>10 W</b>

Beam 40° / Angolo 40°

Distance / Distanza

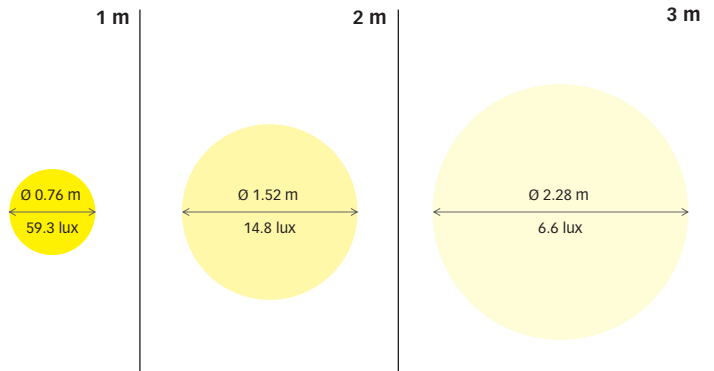
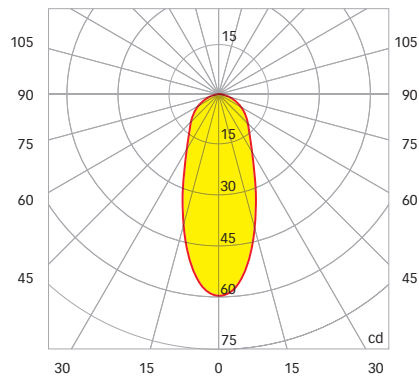

Certifications / Certificazioni



## MINA

RECESSED HALOGEN DOWNLIGHTS  
FARETTI ALOGENI AD INCASSO

Per interni / For interiors



IP40 77 16



## Material / Materiale

AISI 316 Stainless Steel / Acciaio Inox

## Finishes / Finiture\*

-  Mirror polished / Inox lucido
-  Satin / Satinato
-  White 9010 / Bianco 9010

## Dimensions / Dimensioni

 16 mm (5/8 in)

 77 mm (3 in)

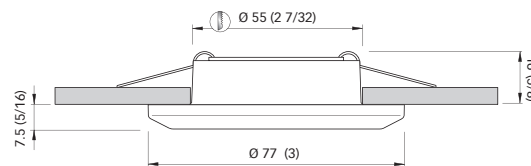
 55 mm (2 7/32 in)

\*Other finishes available upon request / Altre finiture su richiesta

Dimensions in mm (inch)

## SABINE



Socket / Portalamпада	G4
Operating voltage / Voltaggio	12/24 V
Max power / Max potenza	10 W

Beam 40° / Angolo 40°

Distance / Distanza

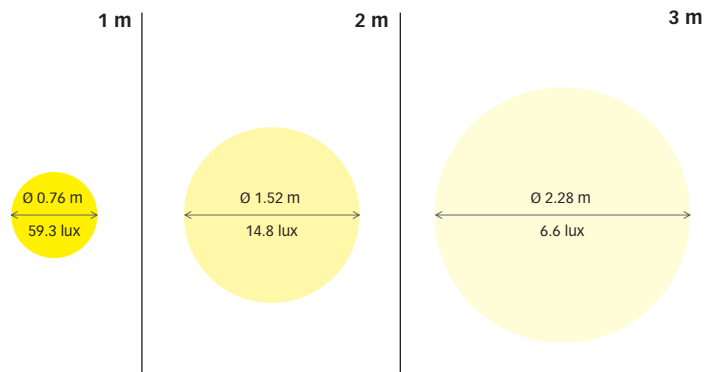
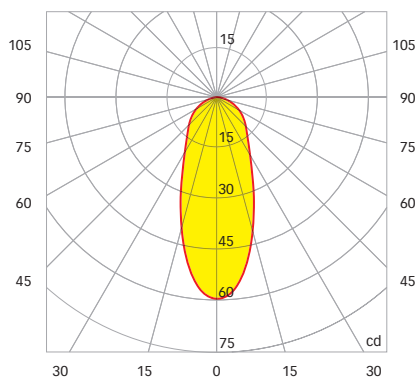

Certifications / Certificazioni



# SABINE

## RECESSED HALOGEN DOWNLIGHTS FARETTI ALOGENI AD INCASSO

Per interni / For interiors



IP40 77 16





### Material / Materiale

AISI 316 Stainless Steel / Acciaio Inox

### Finishes / Finiture\*

-  Mirror polished / Inox lucido
-  Satin / Satinato
-  White 9010 / Bianco 9010

### Dimensions / Dimensioni

-  16 mm (5/8 in)
-  77 mm (3 in)
-  57 mm (2 1/4 in)

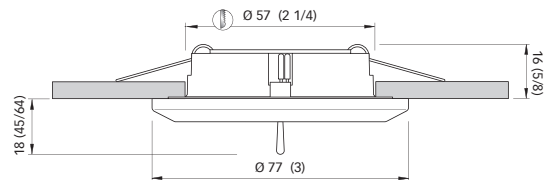

\*Other finishes available upon request / Altre finiture su richiesta

Dimensions in mm (inch)

## ALEX



Socket / Portalampada	G4
Operating voltage / Voltaggio	12/24 V
Max power / Max potenza	20 W

Beam 45° / Angolo 45°

Distance / Distanza

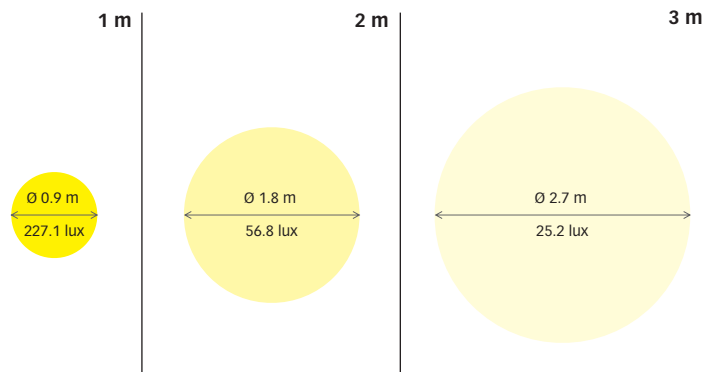
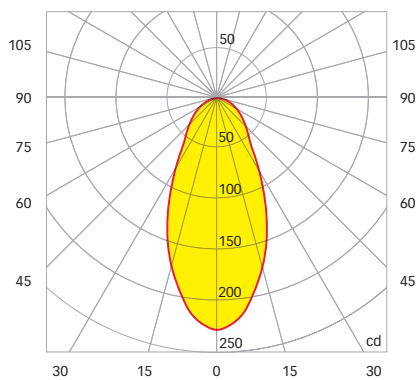

Certifications / Certificazioni



## ALEX

RECESSED HALOGEN DOWNLIGHTS  
FARETTI ALOGENI AD INCASSO



For exterior and interior applications / Per esterni ed interni



## Material / Materiale

AISI 316 Stainless Steel / Acciaio Inox

## Finishes / Finiture\*

-  Mirror polished / Inox lucido
-  Satin / Satinato
-  White 9010 / Bianco 9010

## Dimensions / Dimensioni

-  24 mm (55/64 in)
-  80 mm (3 5/32 in)
-  66 mm (2 19/32 in)

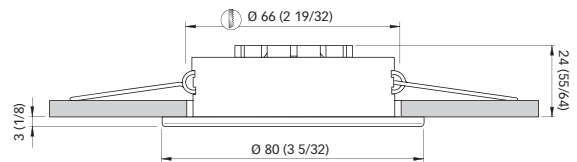

\*Other finishes available upon request / Altre finiture su richiesta

Dimensions in mm (inch)

## LAWRENCE



Socket / Portalampada	G4
Operating voltage / Voltaggio	12/24 V
Max power / Max potenza	20 W

Beam 30° / Angolo 30°

Distance / Distanza

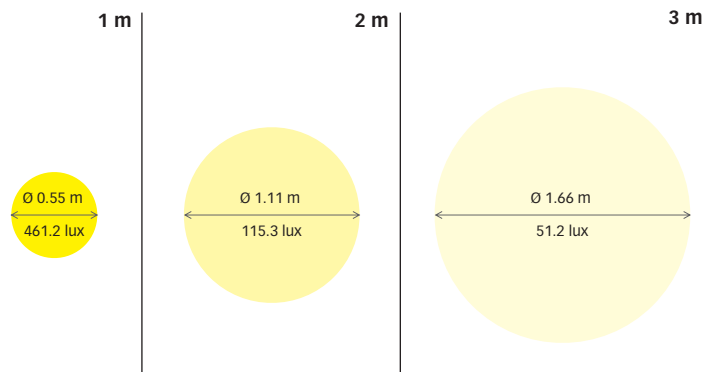
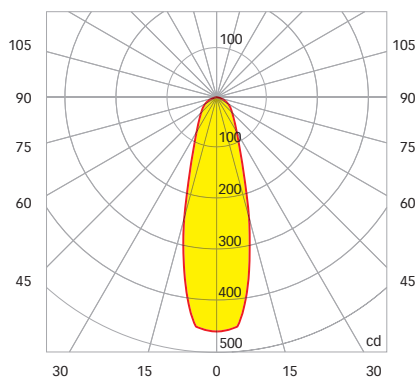

Certifications / Certificazioni



QUICK MARINE LIGHTING



## LAWRENCE

RECESSED HALOGEN DOWNLIGHTS  
FARETTI ALOGENI AD INCASSO



For exterior and interior applications / Per esterni ed interni



## Material / Materiale

AISI 316 Stainless Steel / Acciaio Inox

## Finishes / Finiture\*

-  Mirror polished / Inox lucido
-  Satin / Satinato
-  White 9010 / Bianco 9010

## Dimensions / Dimensioni

 **41 mm** (1 39/64 in)

 **80 mm** (3 5/32 in)

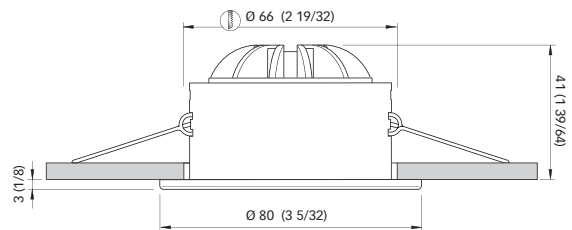
 **66 mm** (2 19/32 in)

Dimensions in mm (inch)

\*Other finishes available upon request / Altre finiture su richiesta

## LUCREZIA



Socket / Portalamпада	G4
Operating voltage / Voltaggio	12/24 V
Max power / Max potenza	20 W

Beam 30° / Angolo 30°

Distance / Distanza

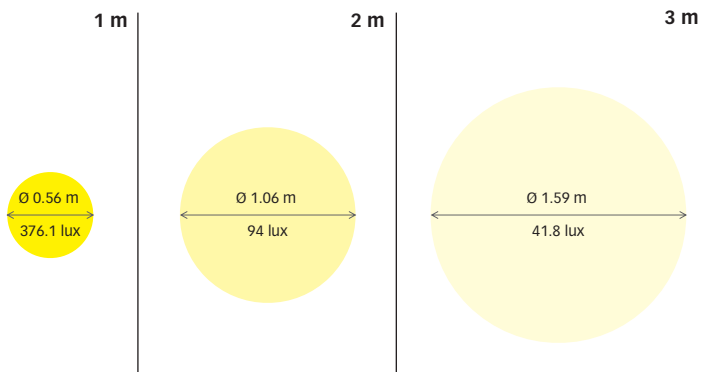
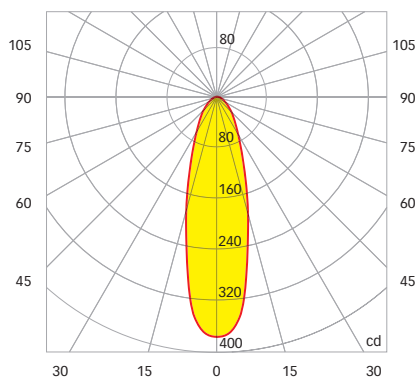

Certifications / Certificazioni



## LUCREZIA

RECESSED HALOGEN DOWNLIGHTS  
FARETTI ALOGENI AD INCASSO

Per interni / For interiors

Adjustable  
DOWNLIGHT

IP40

80



35



## Material / Materiale

AISI 316 Stainless Steel / Acciaio Inox

## Finishes / Finiture\*

-  Mirror polished / Inox lucido
-  Satin / Satinato
-  White 9010 / Bianco 9010

## Dimensions / Dimensioni

 **35 mm** (1 3/8 in)

 **80 mm** (3 5/32 in)

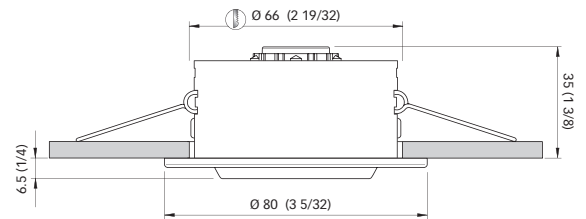
 **66 mm** (2 19/32 in)

Dimensions in mm (inch)

\*Other finishes available upon request / Altre finiture su richiesta

## BORIS



Socket / Portalampada	G4
Operating voltage / Voltaggio	12/24 V
Max power / Max potenza	20 W

Beam 45° / Angolo 45°

Distance / Distanza

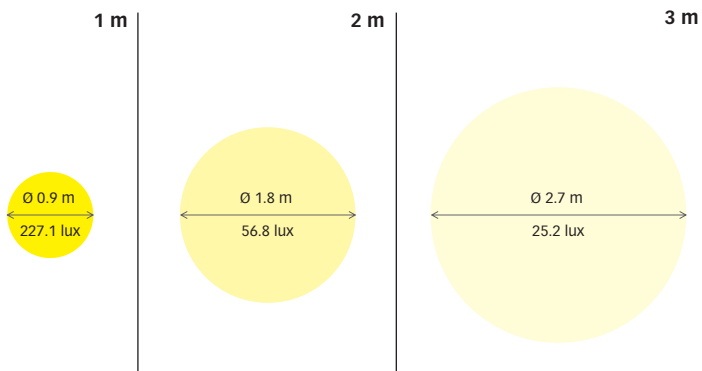
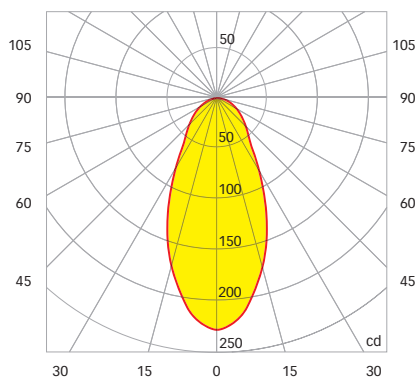



Certifications / Certificazioni





**BORIS****RECESSED HALOGEN DOWNLIGHTS  
FARETTI ALOGENI AD INCASSO**

For exterior and interior applications / Per esterni ed interni

**Material / Materiale****AISI 316 Stainless Steel / Acciaio Inox****Finishes / Finiture\***

-  Mirror polished / Inox lucido
-  Satin / Satinato
-  White 9010 / Bianco 9010

**Dimensions / Dimensioni**

-  **22 mm** (15/16 in)
-  **80 mm** (3 5/32 in)
-  **66 mm** (2 19/32 in)

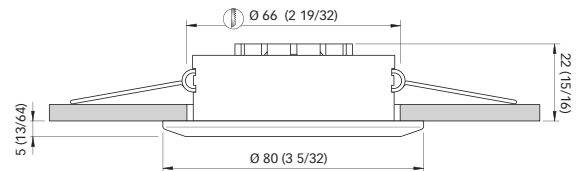

\*Other finishes available upon request / Altre finiture su richiesta

Dimensions in mm (inch)

## ANDREAS



Socket / Portalamпада	G4
Operating voltage / Voltaggio	12/24 V
Max power / Max potenza	20 W

Beam 30° / Angolo 30°

Distance / Distanza

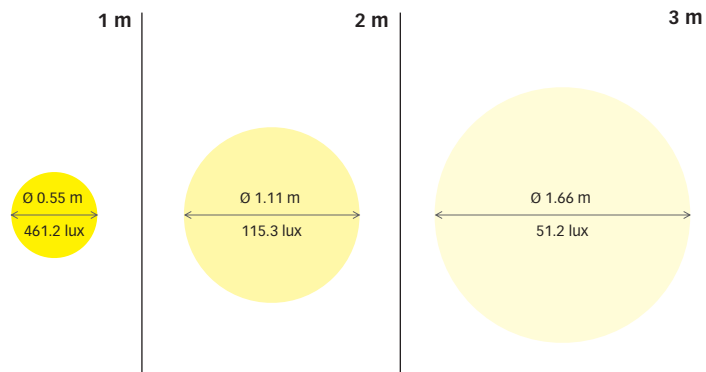
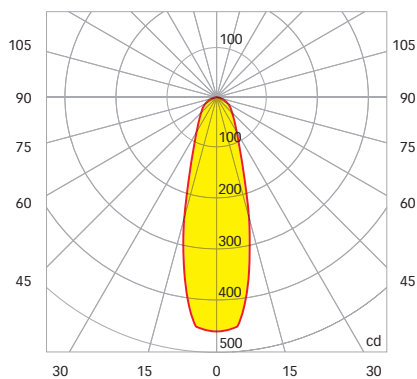

Certifications / Certificazioni



## ANDREAS

RECESSED HALOGEN DOWNLIGHTS  
FARETTI ALOGENI AD INCASSO



For exterior and interior applications / Per esterni ed interni



## Material / Materiale

AISI 316 Stainless Steel / Acciaio Inox

## Finishes / Finiture\*

-  Mirror polished / Inox lucido
-  Satin / Satinato
-  White 9010 / Bianco 9010

## Dimensions / Dimensioni

 **39 mm** (1 17/32 in)

 **80 mm** (3 5/32 in)

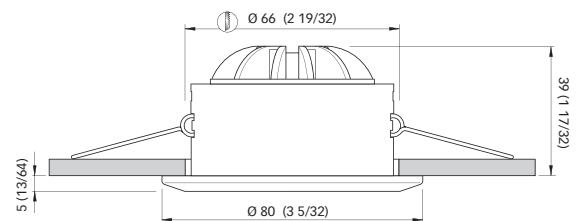
 **66 mm** (2 19/32 in)

Dimensions in mm (inch)

\*Other finishes available upon request / Altre finiture su richiesta

## ELISABETH



Socket / Portalamпада	G4
Operating voltage / Voltaggio	12/24 V
Max power / Max potenza	20 W

Beam 30° / Angolo 30°

Distance / Distanza

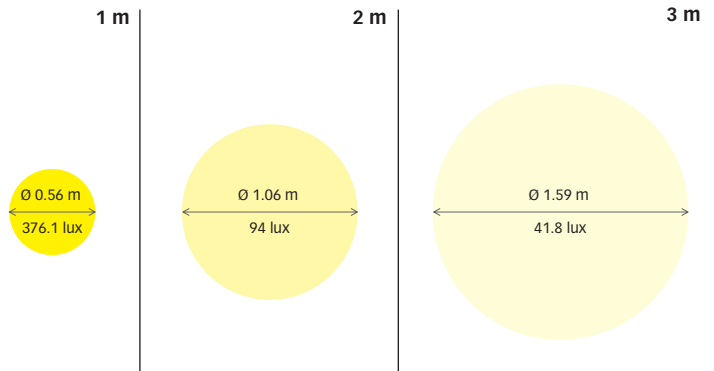
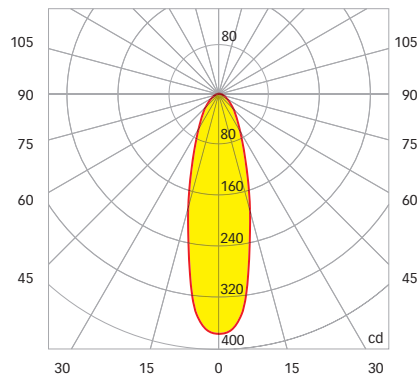

Certifications / Certificazioni



## ELISABETH

RECESSED HALOGEN DOWNLIGHTS  
FARETTI ALOGENI AD INCASSO

Per interni / For interiors

Adjustable  
DOWNLIGHT

IP40

80



33



## Material / Materiale

AISI 316 Stainless Steel / Acciaio Inox

## Finishes / Finiture\*

-  Mirror polished / Inox lucido
-  Satin / Satinato
-  White 9010 / Bianco 9010

## Dimensions / Dimensioni

 **33 mm** (1 19/64 in)

 **80 mm** (3 5/32 in)

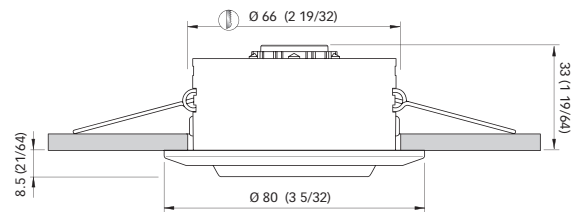
 **66 mm** (2 19/32 in)

\*Other finishes available upon request / Altre finiture su richiesta

Dimensions in mm (inch)

## GIULIA



Socket / Portalampada	G4
Operating voltage / Voltaggio	12/24 V
Max power / Max potenza	20 W

Beam 60° / Angolo 60°

Distance / Distanza

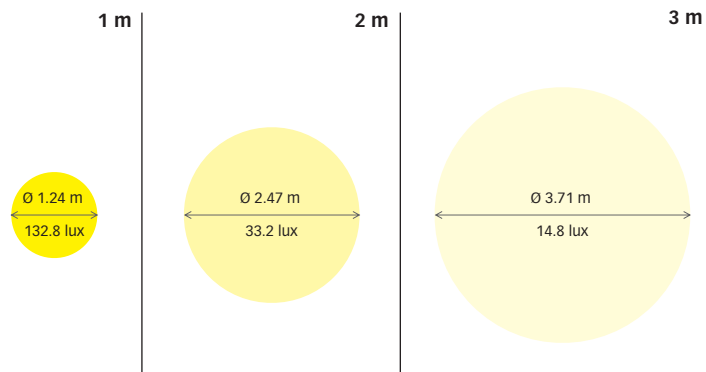
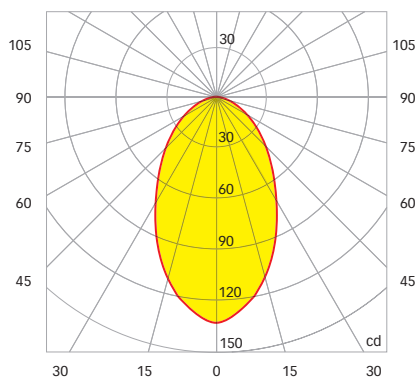

Certifications / Certificazioni



## GIULIA

RECESSED HALOGEN DOWNLIGHTS  
FARETTI ALOGENI AD INCASSO



For exterior and interior applications / Per esterni ed interni





## Material / Materiale

AISI 316 Stainless Steel / Acciaio Inox

## Finishes / Finiture\*

-  Mirror polished / Inox lucido
-  Satin / Satinato
-  White 9010 / Bianco 9010

## Dimensions / Dimensioni

-  **23 mm** (29/32 in)
-  **87 mm** (3 7/16 in)
-  **66 mm** (2 19/32 in)

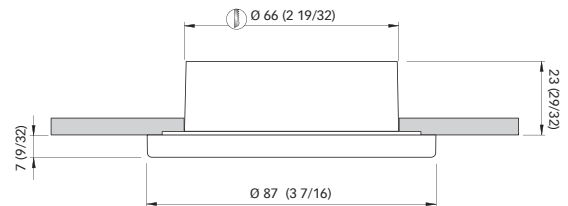

\*Other finishes available upon request / Altre finiture su richiesta

Dimensions in mm (inch)



## SILVIA



Socket / Portalampada	<b>G4</b>
Operating voltage / Voltaggio	12/24 V
Max power / Max potenza	<b>20 W</b>

Beam 75° / Angolo 75°

Distance / Distanza

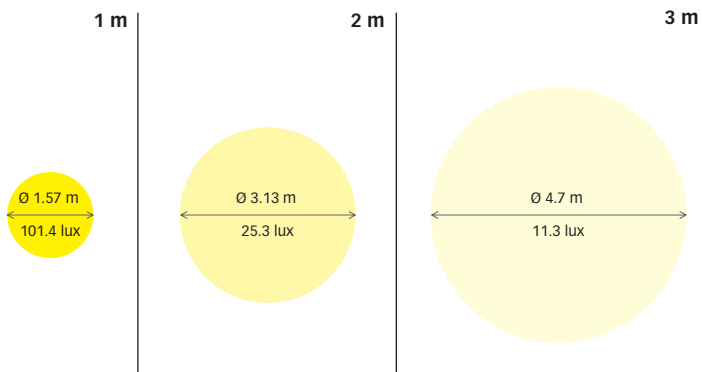
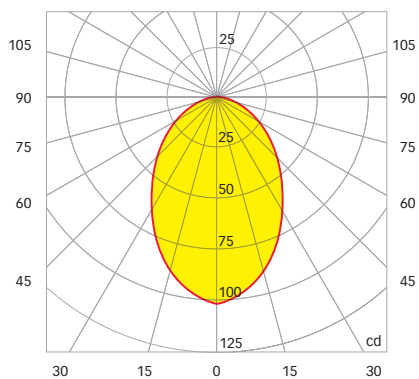

Certifications / Certificazioni



## SILVIA

RECESSED HALOGEN DOWNLIGHTS  
FARETTI ALOGENI AD INCASSO



For exterior and interior applications / Per esterni ed interni





## Material / Materiale

AISI 316 Stainless Steel / Acciaio Inox

## Finishes / Finiture\*

-  Mirror polished / Inox lucido
-  Satin / Satinato
-  White 9010 / Bianco 9010

## Dimensions / Dimensioni

-  24 mm (55/64 in)
-  105 mm (4 9/64 in)
-  80 mm (3 5/32 in)

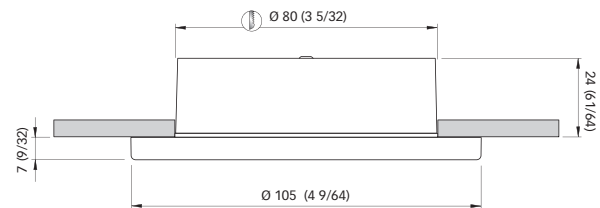

\*Other finishes available upon request / Altre finiture su richiesta

Dimensions in mm (inch)

## TOSCA



Socket / Portalampada	<b>G4</b>	<b>G9</b>
Operating voltage / Voltaggio	12/24 V	110/230 V
Max power / Max potenza	<b>20 W</b>	<b>20 W</b>

Beam 115° / Angolo 115°

Distance / Distanza

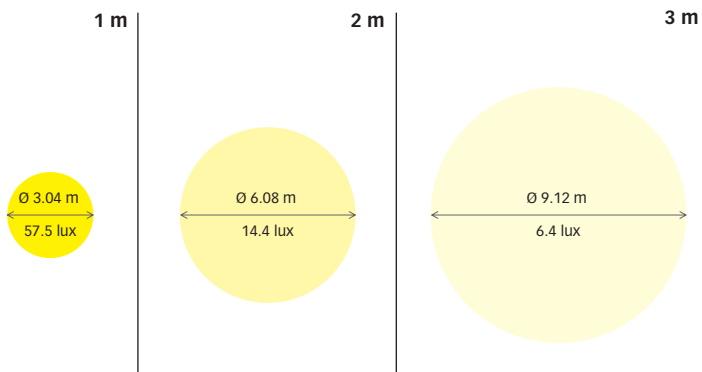
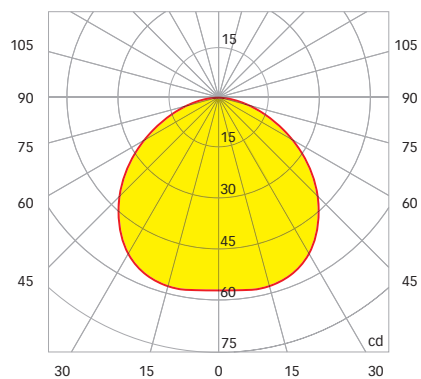

Certifications / Certificazioni



G4

G9

TOSCA

RECESSED HALOGEN DOWNLIGHTS  
FARETTI ALOGENI AD INCASSO



For exterior and interior applications / Per esterni ed interni



## Material / Materiale

AISI 316 Stainless Steel / Acciaio Inox

## Finishes / Finiture\*

-  Mirror polished / Inox lucido
-  Satin / Satinato
-  White 9010 / Bianco 9010

## Dimensions / Dimensioni

 **25 mm** (63/64 in)

 **155 mm** (6 7/64 in)

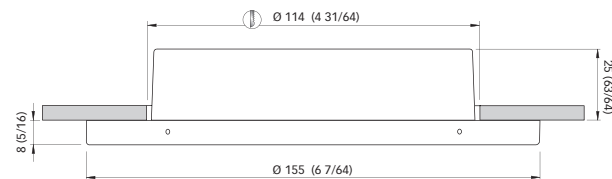
 **114 mm** (4 31/64 in)

Dimensions in mm (inch)

\*Other finishes available upon request / Altre finiture su richiesta

## CARMEN



Socket / Portalampada	<b>G4</b>	<b>G9</b>
Operating voltage / Voltaggio	12/24 V	110/230 V
Max power / Max potenza	<b>20 W</b>	<b>20 W</b>

Beam 115° / Angolo 115°

Distance / Distanza

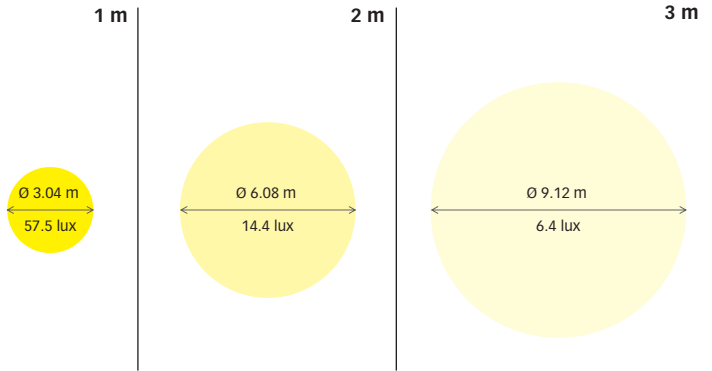
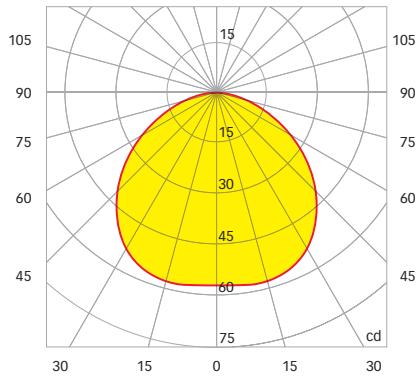

Certifications / Certificazioni



G4 G9

**CARMEN****RECESSED HALOGEN DOWNLIGHTS  
FARETTI ALOGENI AD INCASSO**

For exterior and interior applications / Per esterni ed interni

**Material / Materiale**

AISI 316 Stainless Steel / Acciaio Inox

**Finishes / Finiture**
 Mirror polished / Inox lucido
**Dimensions / Dimensioni**
 **25 mm** (63/64 in)

 **155 mm** (6 7/64 in)

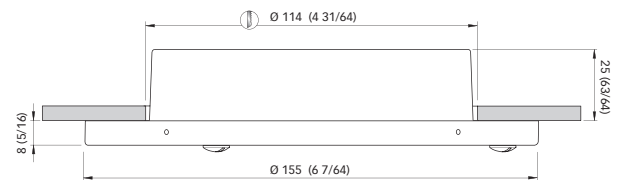
 **114 mm** (4 31/64 in)

Dimensions in mm (inch)

## EDGAR



Socket / Portalamпада	G4
Operating voltage / Voltaggio	12/24 V
Max power / Max potenza	10 W

Angolo 40° / Beam 40°

Distance / Distanza

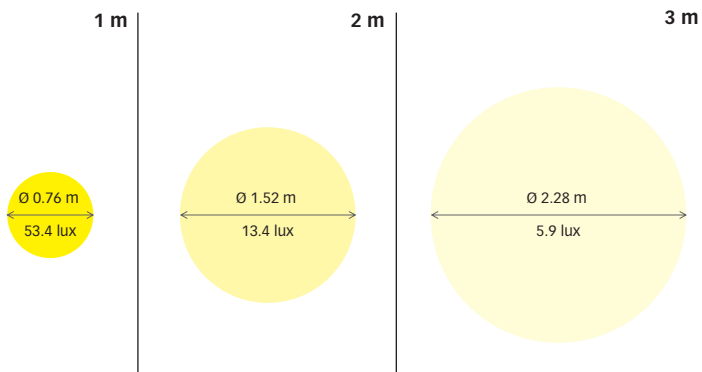
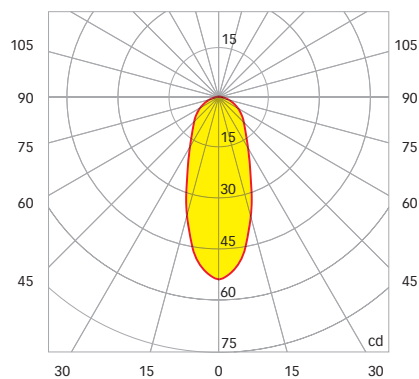

Certifications / Certificazioni



## EDGAR

RECESSED HALOGEN DOWNLIGHTS  
FARETTI ALOGENI AD INCASSO

Per interni / For interiors



IP40 72 17





## Material / Materiale

AISI 316 Stainless Steel / Acciaio Inox

## Finishes / Finiture\*

-  Mirror polished / Inox lucido
-  Satin / Satinato
-  White 9010 / Bianco 9010

## Dimensions / Dimensioni

-  17 mm (43/64 in)
-  72 mm (2 53/64 in)
-  54 mm (2 1/8 in)

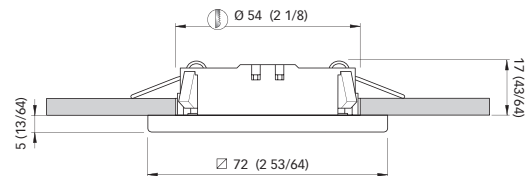

\*Other finishes available upon request / Altre finiture su richiesta

Dimensions in mm (inch)

## BERNARD



Socket / Portalamпада	G4
Operating voltage / Voltaggio	12/24 V
Max power / Max potenza	10 W

Beam 40° / Angolo 40°

Distance / Distanza

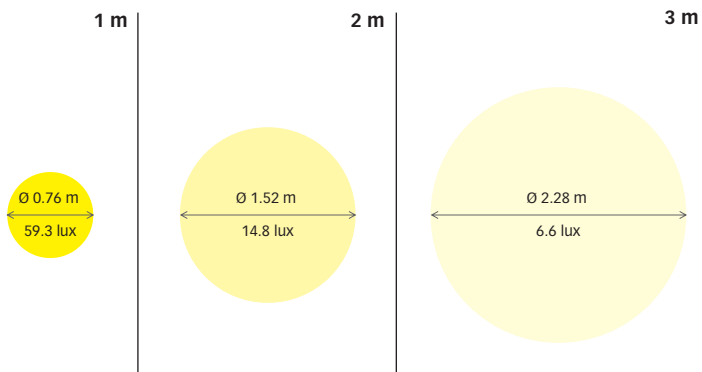
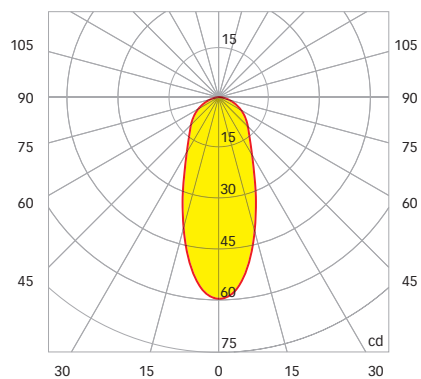

Certifications / Certificazioni





Per interni / For interiors





**Material / Materiale**

**AISI 316 Stainless Steel / Acciaio Inox**

**Finishes / Finiture\***

-  Mirror polished / Inox lucido
-  Satin / Satinato
-  White 9010 / Bianco 9010

**Dimensions / Dimensioni**

-  **17 mm** (43/64 in)
-  **72 mm** (2 53/64 in)
-  **54 mm** (2 1/8 in)

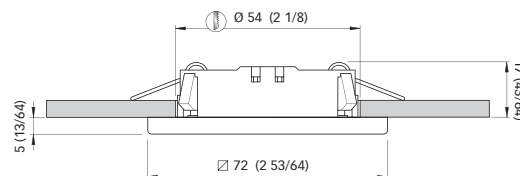

\*Other finishes available upon request / Altre finiture su richiesta

Dimensions in mm (inch)



## LISA



Socket / Portalampada	G4
Operating voltage / Voltaggio	12/24 V
Max power / Max potenza	20 W

Beam 50° / Angolo 50°

Distance / Distanza

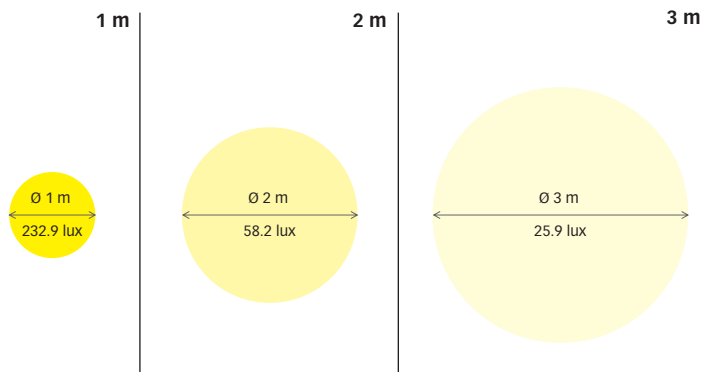
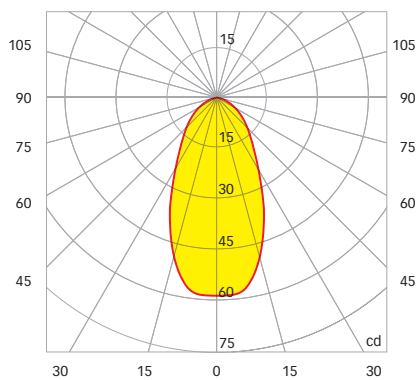

Certifications / Certificazioni



## LISA

RECESSED HALOGEN DOWNLIGHTS  
FARETTI ALOGENI AD INCASSO



For exterior and interior applications / Per esterni ed interni





## Material / Materiale

AISI 316 Stainless Steel / Acciaio Inox

## Finishes / Finiture\*

-  Mirror polished / Inox lucido
-  Satin / Satinato
-  White 9010 / Bianco 9010

## Dimensions / Dimensioni

-  24 mm (55/64 in)
-  72 mm (2 53/64 in)
-  66 mm (2 19/32 in)

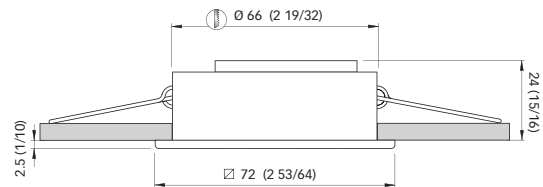

\*Other finishes available upon request / Altre finiture su richiesta

Dimensions in mm (inch)

## LARA



Socket / Portalamпада	G4
Operating voltage / Voltaggio	12/24 V
Max power / Max potenza	20 W

Beam 30° / Angolo 30°

Distance / Distanza

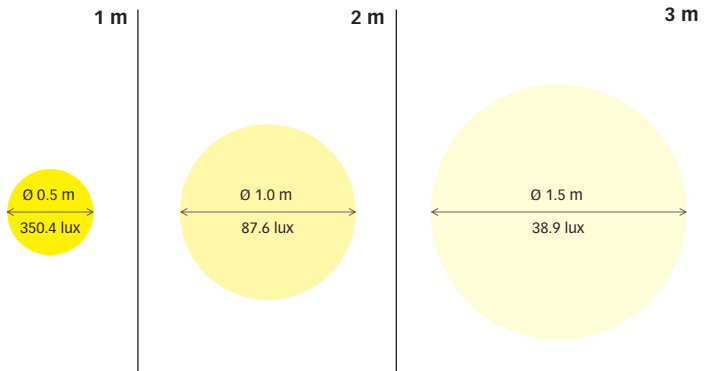
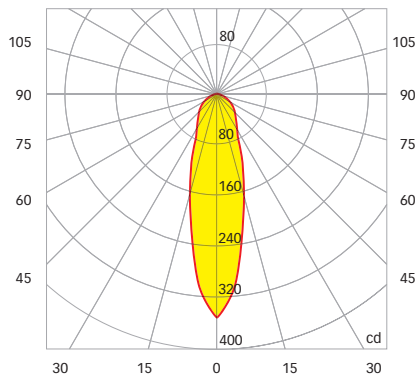

Certifications / Certificazioni



## LARA

RECESSED HALOGEN DOWNLIGHTS  
FARETTI ALOGENI AD INCASSO



For exterior and interior applications / Per esterni ed interni





## Material / Materiale

AISI 316 Stainless Steel / Acciaio Inox

## Finishes / Finiture\*

-  Mirror polished / Inox lucido
-  Satin / Satinato
-  White 9010 / Bianco 9010

## Dimensions / Dimensioni

-  **39 mm** (1 17/32 in)
-  **72 mm** (2 53/64 in)
-  **66 mm** (2 19/32 in)

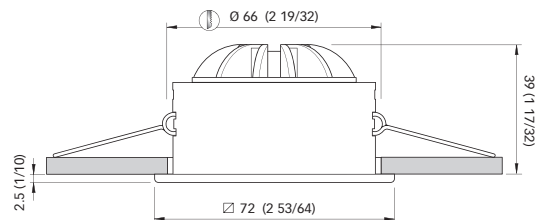

\*Other finishes available upon request / Altre finiture su richiesta

Dimensions in mm (inch)

## HALOGEN SURFACE-MOUNT FIXTURES PLAFONIERE ALOGENE



IP40 - Ø 90 / Thickness 22



IP40 - Ø 90 / Thickness 22

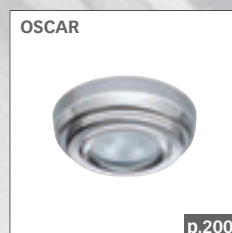

IP40 - Ø 90 / Thickness 23

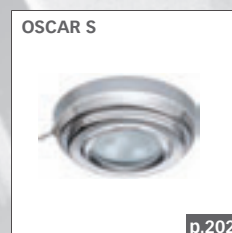

IP40 - Ø 90 / Thickness 23

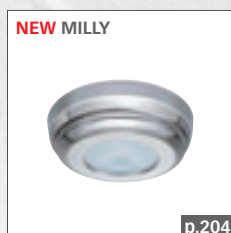

IP40 - Ø 90 / Thickness 25



IP40 - Ø 90 / Thickness 25

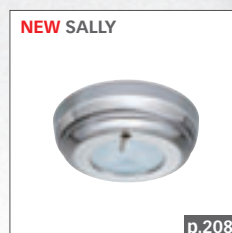

IP40 - Ø 90 / Thickness 25

IP40 = for interior applications only  
IP40 = solo per interni

IP65 = for interior and exterior applications  
IP65 = per interni ed esterni

Dimensions of diameter/maximum trim ring side length and recess are listed in mm  
Le dimensioni del diametro/lato max cornice e del recesso sono indicati in mm

# HALOGEN SURFACE-MOUNT FIXTURES

FOR INTERIORS

HALOGEN SURFACE-MOUNT FIXTURES FOR INTERIORS.  
TRIM RINGS IN AISI 316 STAINLESS STEEL.  
HALOGEN LIGHT SOURCE.

PLAFONIERA PER INTERNI (IP40).  
CORNICI IN ACCIAIO INOX AISI 316.  
SORGENTE DI LUCE ALOGENA.

MODELS IN ALPHABETICAL ORDER

<b>NEW</b>   MILLY	p. 204
<b>NEW</b>   MILLY S	p. 206
OSCAR	p. 200
OSCAR S	p. 202
<b>NEW</b>   SALLY	p. 208
TOM	p. 196
TOM S	p. 198

## TOM



Socket / Portalampada	<b>G4</b>
Operating voltage / Voltaggio	12/24 V
Max power / Max potenza	<b>10 W</b>

Beam 40° / Angolo 40°

Distance / Distanza

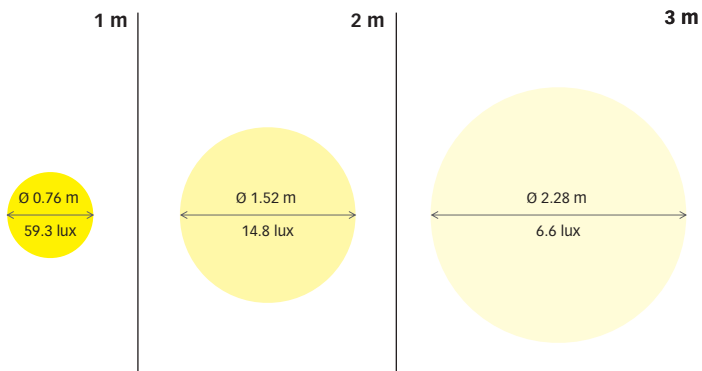
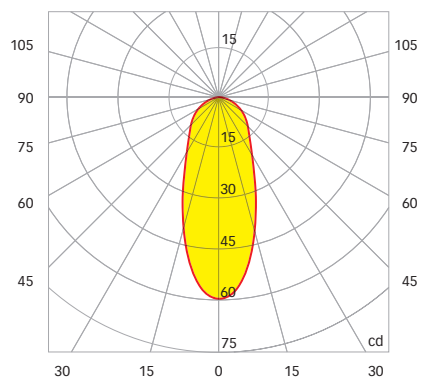

Certifications / Certificazioni



## TOM

HALOGEN SURFACE-MOUNT FIXTURES  
PLAFONIERA ALOGENA



Per interni / For interiors



## Material / Materiale

AISI 316 Stainless Steel / Acciaio Inox

## Finishes / Finiture\*

-  Mirror polished / Inox lucido
-  Satin / Satinato
-  White 9010 / Bianco 9010

## Dimensions / Dimensioni

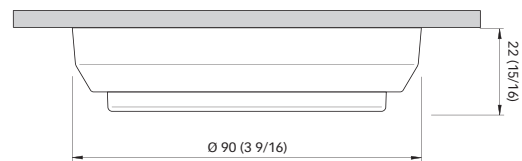
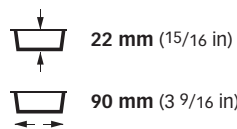

\*Other finishes available upon request / Altre finiture su richiesta

Dimensions in mm (inch)

## TOM S



Socket / Portalampada	<b>G4</b>
Operating voltage / Voltaggio	12/24 V
Max power / Max potenza	<b>10 W</b>

Beam 40° / Angolo 40°

Distance / Distanza

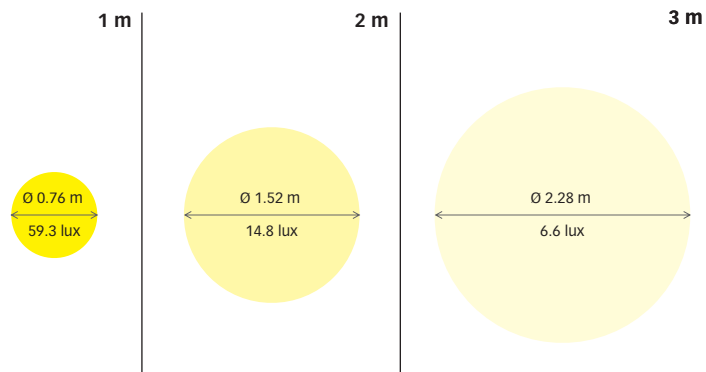
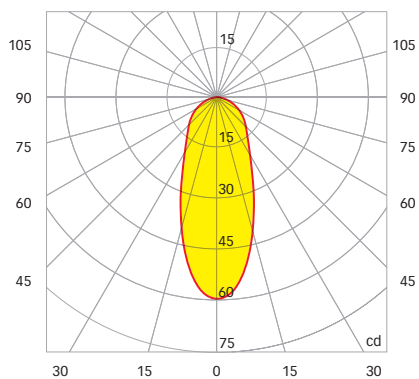

Certifications / Certificazioni



## TOM S

HALOGEN SURFACE-MOUNT FIXTURES  
PLAFONIERA ALOGENA



Per interni / For interiors

Con interruttore  
With switch

## Material / Materiale

AISI 316 Stainless Steel / Acciaio Inox

## Finishes / Finiture\*

-  Mirror polished / Inox lucido
-  Satin / Satinato
-  White 9010 / Bianco 9010

## Dimensions / Dimensioni

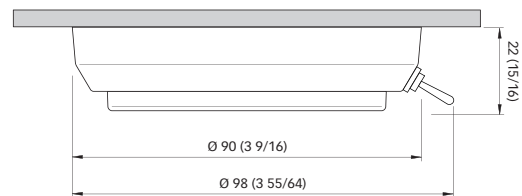
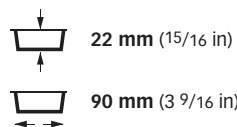

Dimensions in mm (inch)

\*Other finishes available upon request / Altre finiture su richiesta

## OSCAR



Socket / Portalamпада	<b>G4</b>
Operating voltage / Voltaggio	12/24 V
Max power / Max potenza	<b>10 W</b>

Beam 40° / Angolo 40°

Distance / Distanza

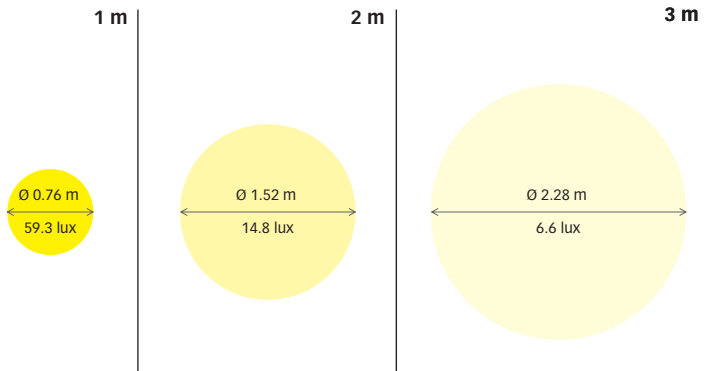
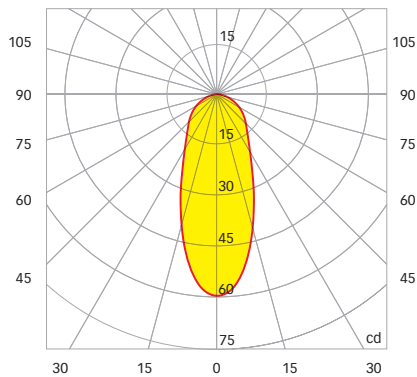

Certifications / Certificazioni



## OSCAR

HALOGEN SURFACE-MOUNT FIXTURES  
PLAFONIERA ALOGENA



Per interni / For interiors



## Material / Materiale

AISI 316 Stainless Steel / Acciaio Inox

## Finishes / Finiture\*

-  Mirror polished / Inox lucido
-  Satin / Satinato
-  White 9010 / Bianco 9010

## Dimensions / Dimensioni

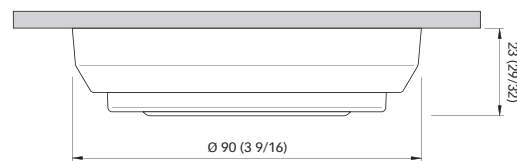
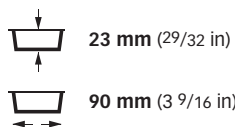

\*Other finishes available upon request / Altre finiture su richiesta

Dimensions in mm (inch)



## OSCAR S



Socket / Portalampada	<b>G4</b>
Operating voltage / Voltaggio	12/24 V
Max power / Max potenza	<b>10 W</b>

Beam 40° / Angolo 40°

Distance / Distanza

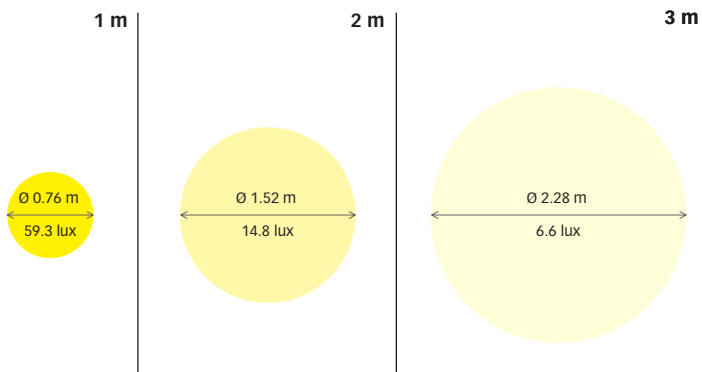
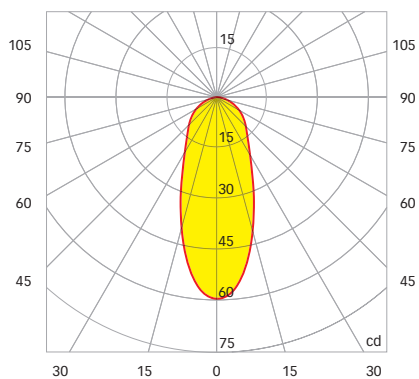

Certifications / Certificazioni



## OSCAR S

HALOGEN SURFACE-MOUNT FIXTURES  
PLAFONIERA ALOGENA



Per interni / For interiors

Con interruttore  
With switch

## Material / Materiale

AISI 316 Stainless Steel / Acciaio Inox

## Finishes / Finiture\*

-  Mirror polished / Inox lucido
-  Satin / Satinato
-  White 9010 / Bianco 9010

## Dimensions / Dimensioni

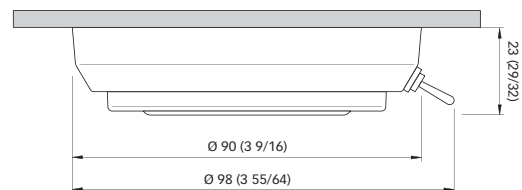
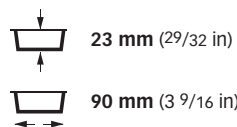

Dimensions in mm (inch)

\*Other finishes available upon request / Altre finiture su richiesta



**NEW | MILLY**

Socket / Portalampada	<b>G4</b>
Operating voltage / Voltaggio	12/24 V
Max power / Max potenza	<b>10 W</b>

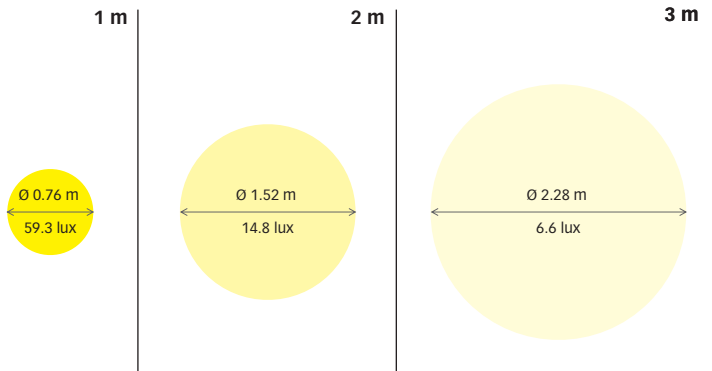
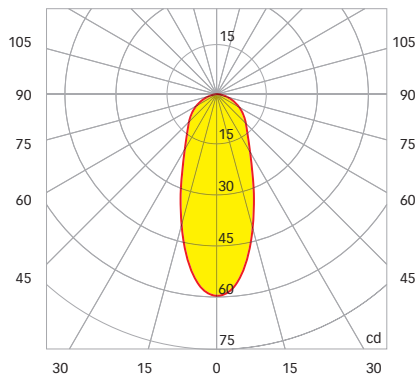
**Beam 40° / Angolo 40°****Distance / Distanza****Certifications / Certificazioni**

**NEW** | MILLY

## HALOGEN SURFACE-MOUNT FIXTURES PLAFONIERA ALOGENA

11



Per interni / For interiors



### Material / Materiale

AISI 316 Stainless Steel / Acciaio Inox

### Finishes / Finiture\*

-  Mirror polished / Inox lucido
-  Satin / Satinato
-  White 9010 / Bianco 9010

### Dimensions / Dimensioni

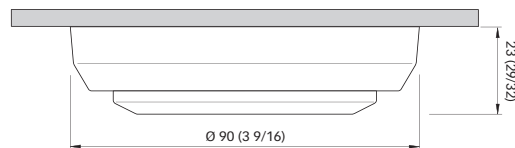
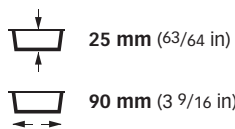

\*Other finishes available upon request / Altre finiture su richiesta

Dimensions in mm (inch)

QUICK MARINE LIGHTING



## NEW | MILLY S



Socket / Portalamпада	<b>G4</b>
Operating voltage / Voltaggio	12/24 V
Max power / Max potenza	<b>10 W</b>

Beam 40° / Angolo 40°

Distance / Distanza

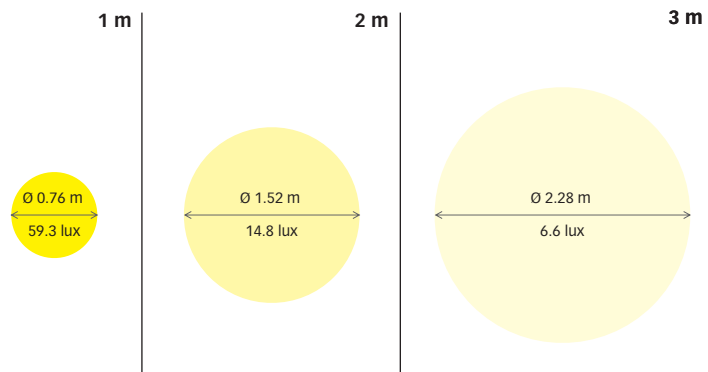
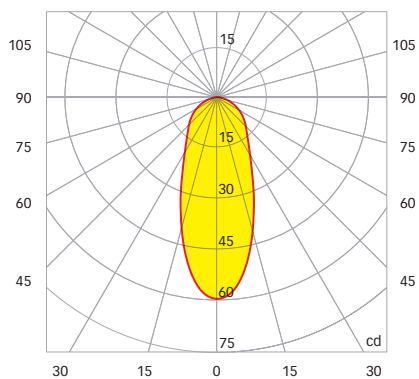

Certifications / Certificazioni





**NEW | MILLY S****HALOGEN SURFACE-MOUNT FIXTURES  
PLAFONIERA ALOGENA**

Per interni / For interiors

Con interruttore  
With switch**Material / Materiale**

AISI 316 Stainless Steel / Acciaio Inox

**Finishes / Finiture\***

-  Mirror polished / Inox lucido
-  Satin / Satinato
-  White 9010 / Bianco 9010

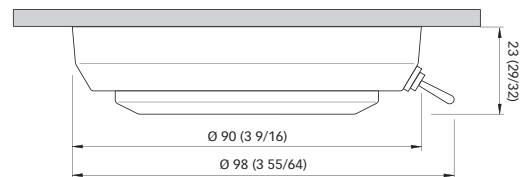
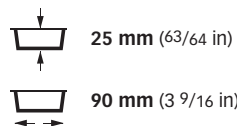
**Dimensions / Dimensioni**

Dimensions in mm (inch)

\*Other finishes available upon request / Altre finiture su richiesta



**NEW | SALLY**

Socket / Portalamпада	<b>G4</b>
Operating voltage / Voltaggio	12/24 V
Max power / Max potenza	<b>10 W</b>

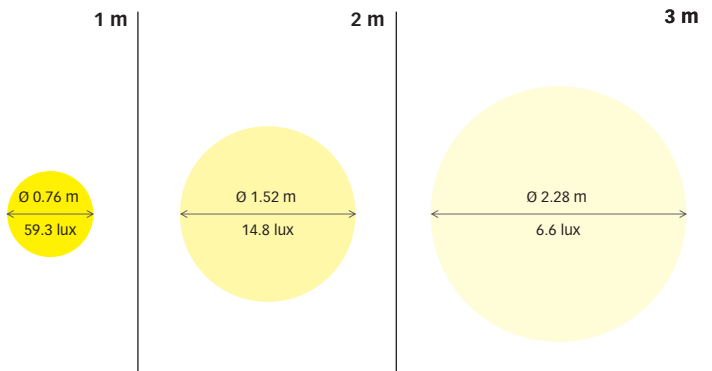
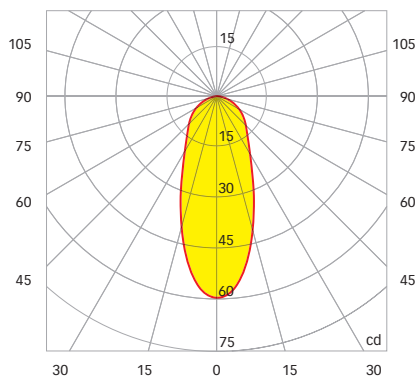
**Beam 40° / Angolo 40°****Distance / Distanza****Certifications / Certificazioni**

**NEW** | SALLY

## HALOGEN SURFACE-MOUNT FIXTURES PLAFONIERA ALOGENA

11



Per interni / For interiors



### Material / Materiale

AISI 316 Stainless Steel / Acciaio Inox

### Finishes / Finiture\*

-  Mirror polished / Inox lucido
-  Satin / Satinato
-  White 9010 / Bianco 9010

### Dimensions / Dimensioni

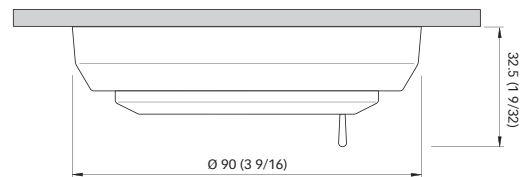
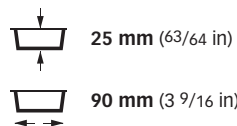

\*Other finishes available upon request / Altre finiture su richiesta

Dimensions in mm (inch)



## HALOGEN READING LIGHTS LUCI DA LETTURA ALOGENE



IP40 - Adjustable

IP40 = for interior applications only  
IP40 = solo per interni

IP65 = for interior and exterior applications  
IP65 = per interni ed esterni

Dimensions of diameter/maximum trim ring side length and recess are listed in mm  
Le dimensioni del diametro/lato max cornice e del recesso sono indicati in mm



QUICK MARINE LIGHTING

# HALOGEN READING LIGHTS

READING LIGHTS.  
WALL AND SURFACE INSTALLATION.  
ADJUSTABLE.  
HALOGEN LIGHT SOURCE

LUCI DA LETTURA (IP40).  
INSTALLAZIONE A PARETE E SU PIANO.  
ORIENTABILI.  
SORGENTE DI LUCE ALOGENA.

12

JOYCE

p. 212

Socket / Portalampada	<b>G4</b>
Operating voltage / Voltaggio	12/24 V
Max power / Max potenza	<b>10 W</b>

## Certifications / Certificazioni



## Dimensions / Dimensioni



20 mm (25/32 in)

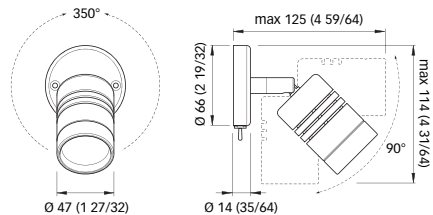

Dimensions in mm (inch)





**NEW | JOYCE****HALOGEN READING LIGHTS  
LUCI DA LETTURA ALOGENE**

Per interni / For interiors

Adjustable  
READING LIGHT

IP40

With switch  
Con interruttore**Materials / Materiali**

-  Chromed aluminium  
Alluminio cromato
-  Anodized aluminium - Black color  
Alluminio anodizzato - Colore Nero



## HALOGEN BULBS

13

XENON G4

p. 215

Xenon gas is colourless and inodorous, not toxic, not corrosive and it preserves the filament. Quick Marine Lighting G4 Xenon bulb is specifically designed for boats.

- More resistant to current spikes
- More resistant to vibrations
- Reinforced filament
- Higher efficiency

Il gas Xenon non ha colore, è inodore, non è tossico, non è corrosivo e preserva il filamento  
La lampadina G4 Xenon di Quick Marine Lighting è specifica per l'ambiente marino.

- Maggiore resistenza agli sbalzi di corrente
- Maggiore resistenza alle vibrazioni
- Filamento rinforzato
- Maggiore efficienza



G4	12 V	5W	Xenon bulb
G4	12 V	10W	Xenon bulb
G4	12 V	20W	Xenon bulb
G4	24 V	10W	Xenon bulb
G4	24 V	20W	Xenon bulb
G4	28 V	20W	Xenon bulb

CE

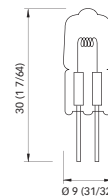

Dimensions in mm (inch)



LAMPSHADES

WALL LIGHTS

14

TABLE LIGHTS

15

## WALL LIGHTS WITH LAMP SHADE APPLIQUE CON PARALUME



Lampshade base Ø 150  
Fix bracket



Lampshade base Ø 150  
Articulated bracket 120



Lampshade base Ø 150  
Articulated bracket 250 max



Lampshade base Ø 180  
Articulated bracket 300 max



Lampshade base Ø 300  
Articulated bracket 300 max



Lampshade base side 100  
Fix bracket



Lampshade side base 150  
Fix bracket



Lampshade base side 100  
Fix bracket



Lampshade base side 150  
Articulated bracket 300 max



Lampshade base side 120  
Articulated bracket 250 max



Lampshade base side 15  
Fix bracket



Lampshade base side 150  
Articulated bracket 300 max



Lampshade base side 180  
Articulated bracket 300 max

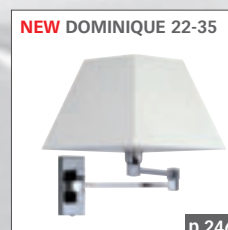

Lampshade base side 220  
Articulated bracket 350 max

Dimensions of diameter/maximum lampshade side length and articulated bracket length are listed in mm  
Le dimensioni del diametro/lato max del paralume e la lunghezza del braccio articolato sono indicati in mm

# WALL LIGHTS WITH LAMPSHADE

WALL LIGHTS WITH LAMPSHADE.  
SUPPORTS IN CHROMED BRASS OR ALUMINUM  
AND ANODIZED ALUMINUM.  
LAMPSHADES IN FABRIC COUPLED TO PVC.  
BULB WITH E14 AND B15d SOCKET.

APPLIQUE CON PARALUME.  
SUPPORTI IN OTTONE O ALLUMINIO CROMATI  
E ALLUMINIO ANODIZZATO.  
PARALUMI IN TESSUTO ACCOPPIATO A PVC.  
LAMPADINA CON ATTACCO E14 E B15d.

MODELS IN ALPHABETICAL ORDER

<b>NEW</b>   DOMINIQUE	p. 240
<b>NEW</b>   DOMITILLA	p. 238
<b>NEW</b>   DOMIZIANA	p. 236
<b>NEW</b>   IOLANDA	p. 228
<b>NEW</b>   ISABELLA	p. 222
<b>NEW</b>   SHARON 10	p. 230
SHARON 15	p. 232
<b>NEW</b>   SHARON 20	p. 234
SHEILA	p. 220

## SHEILA

Socket / Portalamпада	B15d
Operating voltage / Voltaggio	12/24 V
Max power / Max potenza	20 W

Certifications / Certificazioni



Socket / Portalamпада	E14
Operating voltage / Voltaggio	110/220 V
Max power / Max potenza	25 W

Certifications / Certificazioni



## Dimensions / Dimensioni

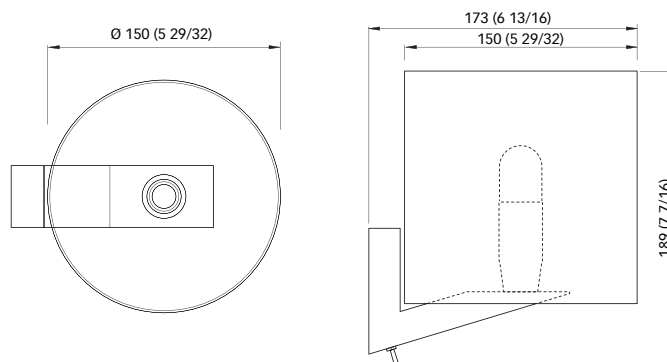

Dimensions in mm (inch)

**Fix bracket / Braccio fisso****Material / Materiale**

Chromed aluminium  
Alluminio cromato







Opaque anodized aluminum  
Alluminio anodizzato opaco

**Lampshade / Paralume****Material / Materiale**

Fabric-PVC / Tessuto-PVC

**Finishes / Finiture\***

	Linen / Lino
	Sand / Sabbia
	Brown / Marrone
	Bordeaux / Bordeaux

\*Other finishes available upon request / Altre finiture su richiesta

**NEW** | ISABELLA 15-12

Socket / Portalampada	B15d
Operating voltage / Voltaggio	12/24 V
Max power / Max potenza	20 W

Certifications / Certificazioni



Socket / Portalampada	E14
Operating voltage / Voltaggio	110/220 V
Max power / Max potenza	25 W

Certifications / Certificazioni

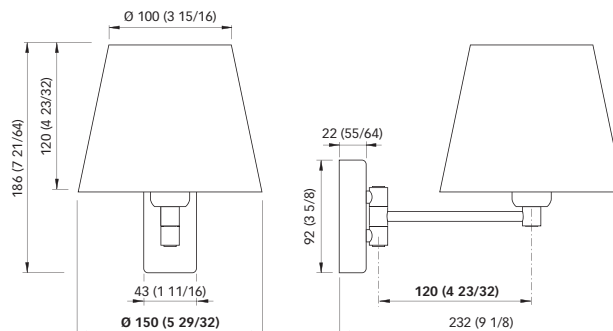
**Dimensions / Dimensioni**

Dimensions in mm (inch)



**Articulated bracket / Braccio snodato**

**Material / Materiale** Brass / Ottone





**Finishes / Finiture**

-  Chromed / Cromo
-  Gold-plated / Oro

**Lampshade / Paralume**

**Material / Materiale** Fabric-PVC / Tessuto-PVC

**Finishes / Finiture\***

-  Linen / Lino
-  Sand / Sabbia
-  Brown / Marrone
-  Bordeaux / Bordeaux

\*Other finishes available upon request / Altre finiture su richiesta

**NEW** | ISABELLA 15-25

Socket / Portalampada	B15d
Operating voltage / Voltaggio	12/24 V
Max power / Max potenza	20 W

Certifications / Certificazioni



Socket / Portalampada	E14
Operating voltage / Voltaggio	110/220 V
Max power / Max potenza	25 W

Certifications / Certificazioni

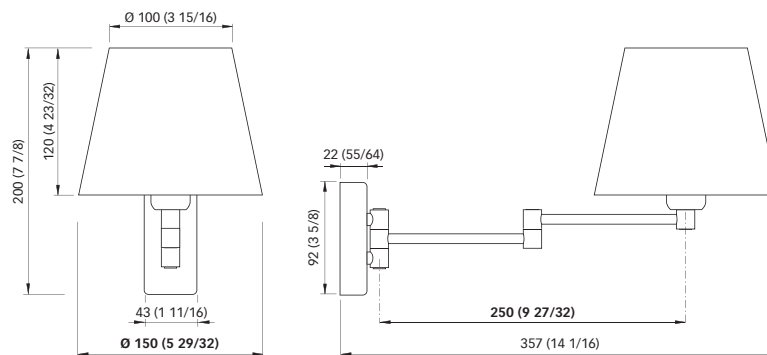
**Dimensions / Dimensioni**

Dimensions in mm (inch)



**Articulated bracket / Braccio snodato**

**Material / Materiale** Brass / Ottone





**Finishes / Finiture**

-  Chromed / Cromo
-  Gold-plated / Oro

**Lampshade / Paralume**

**Material / Materiale** Fabric-PVC / Tessuto-PVC

**Finishes / Finiture\***

-  Linen / Lino
-  Sand / Sabbia
-  Brown / Marrone
-  Bordeaux / Bordeaux

\*Other finishes available upon request / Altre finiture su richiesta

**NEW | ISABELLA 18-30**

Socket / Portalampada	B15d
Operating voltage / Voltaggio	12/24 V
Max power / Max potenza	20 W

Certifications / Certificazioni



Socket / Portalampada	E14
Operating voltage / Voltaggio	110/220 V
Max power / Max potenza	25 W

Certifications / Certificazioni

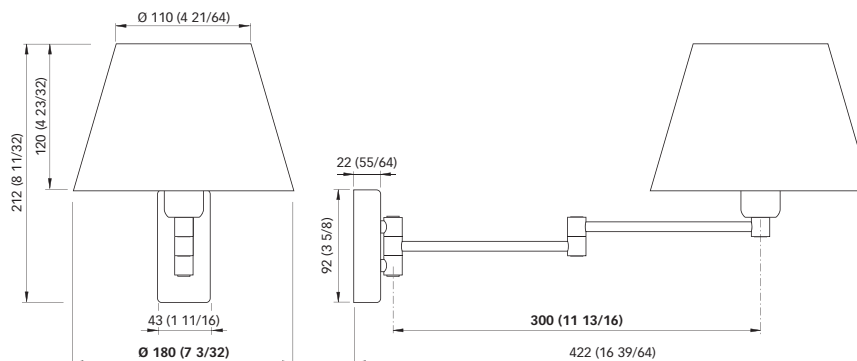
**Dimensions / Dimensioni**

Dimensions in mm (inch)



**Articulated bracket / Braccio snodato**

**Material / Materiale** Brass / Ottone





**Finishes / Finiture**

-  Chromium-plated / Cromo
-  Gold-plated / Oro

**Lampshade / Paralume**

**Material / Materiale** Fabric-PVC / Tessuto-PVC

**Finishes / Finiture\***

-  Linen / Lino
-  Sand / Sabbia
-  Brown / Marrone
-  Bordeaux / Bordeaux

\*Other finishes available upon request / Altre finiture su richiesta

## NEW | IOLANDA 30-30

Socket / Portalampada	B15d
Operating voltage / Voltaggio	12/24 V
Max power / Max potenza	20 W

Certifications / Certificazioni



Socket / Portalampada	E14
Operating voltage / Voltaggio	110/220 V
Max power / Max potenza	25 W

Certifications / Certificazioni



### Dimensions / Dimensioni

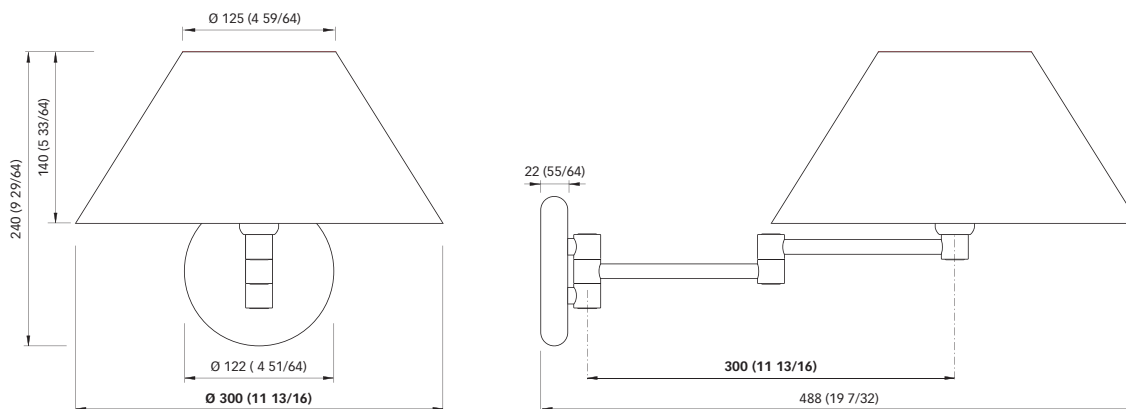

Dimensions in mm (inch)



**Articulated bracket / Braccio snodato**

**Material / Materiale** Brass / Ottone





**Finishes / Finiture**

-  Chromed / Cromo
-  Gold-plated / Oro

**Lampshade / Paralume**

**Material / Materiale** Fabric-PVC / Tessuto-PVC

**Finishes / Finiture\***

-  Linen / Lino
-  Sand / Sabbia
-  Brown / Marrone
-  Bordeaux / Bordeaux

\*Other finishes available upon request / Altre finiture su richiesta

**NEW** | SHARON 10

Socket / Portalampada	B15d
Operating voltage / Voltaggio	12/24 V
Max power / Max potenza	20 W

Certifications / Certificazioni



Socket / Portalampada	E14
Operating voltage / Voltaggio	110/220 V
Max power / Max potenza	25 W

Certifications / Certificazioni

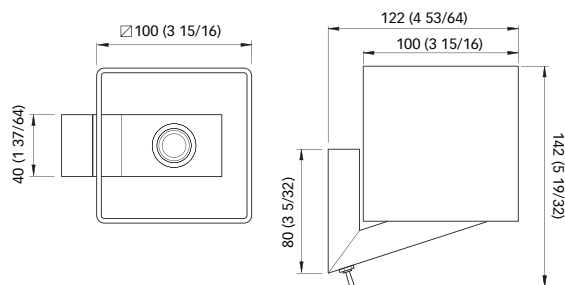
**Dimensions / Dimensioni**

Dimensions in mm (inch)



**Fix bracket / Braccio fisso**

**Material / Materiale**



Chromed aluminium  
Alluminio cromato







Opaque anodized aluminum  
Alluminio anodizzato opaco

**Lampshade / Paralume**

**Material / Materiale**

Fabric-PVC / Tessuto-PVC

**Finishes / Finiture\***

	Linen / Lino
	Sand / Sabbia
	Brown / Marrone
	Bordeaux / Bordeaux

\*Other finishes available upon request / Altre finiture su richiesta

## SHARON 15

Socket / Portalampada	B15d
Operating voltage / Voltaggio	12/24 V
Max power / Max potenza	20 W

Certifications / Certificazioni



Socket / Portalampada	E14
Operating voltage / Voltaggio	110/220 V
Max power / Max potenza	25 W

Certifications / Certificazioni



## Dimensions / Dimensioni

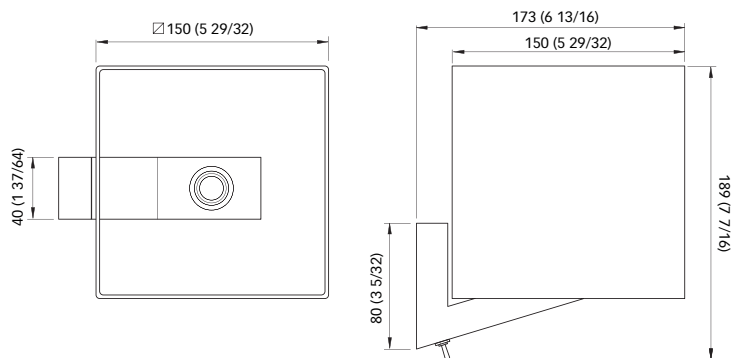

Dimensions in mm (inch)

## SHARON 15

WALL LIGHTS WITH LAMP SHADE  
APPLIQUE CON PARALUME**Fix bracket / Braccio fisso****Material / Materiale**

Chromed aluminium  
Alluminio cromato







Opaque anodized aluminum  
Alluminio anodizzato opaco

**Lampshade / Paralume****Material / Materiale**

Fabric-PVC / Tessuto-PVC

**Finishes / Finiture\***

	Linen / Lino
	Sand / Sabbia
	Brown / Marrone
	Bordeaux / Bordeaux

\*Other finishes available upon request / Altre finiture su richiesta

**NEW | SHARON 20**

Socket / Portalampada	B15d
Operating voltage / Voltaggio	12/24 V
Max power / Max potenza	20 W

Certifications / Certificazioni



Socket / Portalampada	E14
Operating voltage / Voltaggio	110/220 V
Max power / Max potenza	25 W

Certifications / Certificazioni

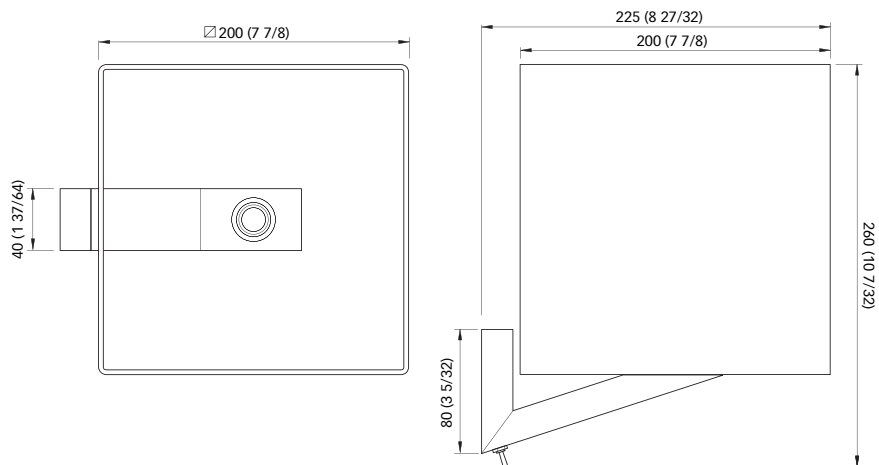
**Dimensions / Dimensioni**

Dimensions in mm (inch)



**Fix bracket / Braccio fisso**

**Material / Materiale**



Chromed alluminim  
Alluminio cromato







Opaque anodized aluminum  
Alluminio anodizzato opaco

**Lampshade / Paralume**

**Material / Materiale**

Fabric-PVC / Tessuto-PVC

**Finishes / Finiture\***

-  Linen / Lino
-  Sand / Sabbia
-  Brown / Marrone
-  Bordeaux / Bordeaux

\*Other finishes available upon request / Altre finiture su richiesta

**NEW | DOMIZIANA 15-30**

Socket / Portalampada	B15d
Operating voltage / Voltaggio	12/24 V
Max power / Max potenza	20 W

Certifications / Certificazioni



Socket / Portalampada	E14
Operating voltage / Voltaggio	110/220 V
Max power / Max potenza	25 W

Certifications / Certificazioni

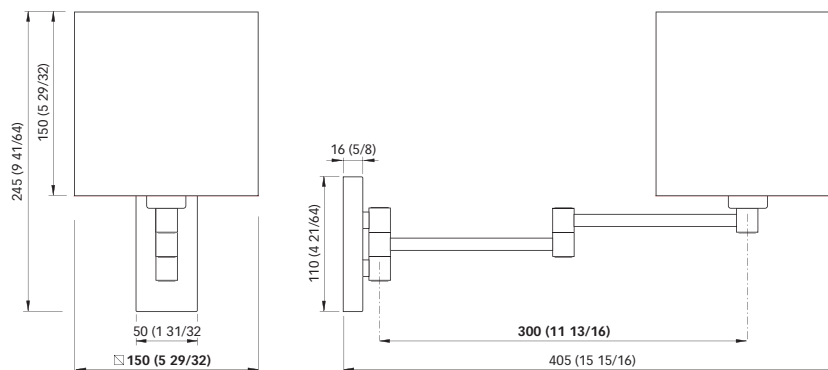
**Dimensions / Dimensioni**

Dimensions in mm (inch)



**Articulated bracket / Braccio snodato**

**Material / Materiale** Brass / Ottone





**Finishes / Finiture**

-  Chromed / Cromo
-  Gold-plated / Oro

**Lampshade / Paralume**

**Material / Materiale** Fabric-PVC / Tessuto-PVC

**Finishes / Finiture\***

-  Linen / Lino
-  Sand / Sabbia
-  Brown / Marrone
-  Bordeaux / Bordeaux

\*Other finishes available upon request / Altre finiture su richiesta

**NEW** | DOMITILLA 12-25

Socket / Portalampada	B15d
Operating voltage / Voltaggio	12/24 V
Max power / Max potenza	20 W

Certifications / Certificazioni



Socket / Portalampada	E14
Operating voltage / Voltaggio	110/220 V
Max power / Max potenza	25 W

Certifications / Certificazioni



## Dimensions / Dimensioni

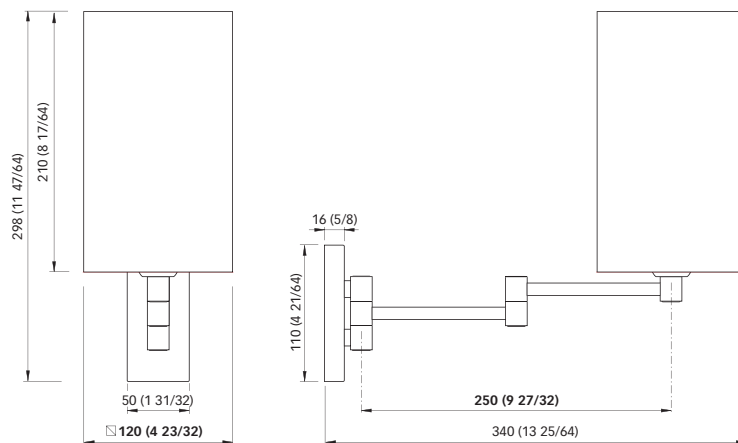

Dimensions in mm (inch)



**Articulated bracket / Braccio snodato**

**Material / Materiale** Brass / Ottone





**Finishes / Finiture**

-  Chromed / Cromo
-  Gold-plated / Oro

**Lampshade / Paralume**

**Material / Materiale** Fabric-PVC / Tessuto-PVC

**Finishes / Finiture\***

-  Linen / Lino
-  Sand / Sabbia
-  Brown / Marrone
-  Bordeaux / Bordeaux

\*Other finishes available upon request / Altre finiture su richiesta

**NEW** | DOMINIQUE 15-9

Socket / Portalampada	B15d
Operating voltage / Voltaggio	12/24 V
Max power / Max potenza	20 W

Certifications / Certificazioni



Socket / Portalampada	E14
Operating voltage / Voltaggio	110/220 V
Max power / Max potenza	25 W

Certifications / Certificazioni



## Dimensions / Dimensioni

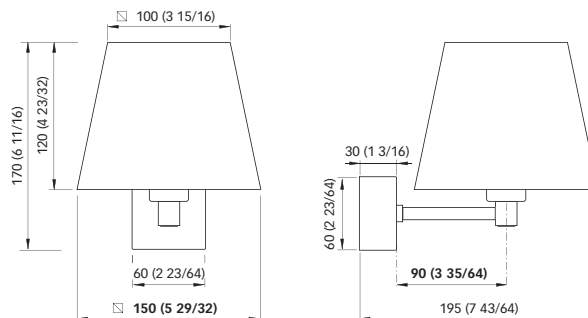

Dimensions in mm (inch)





**Fix bracket / Braccio fisso**

**Material / Materiale** Brass / Ottone



**Finishes / Finiture**

-  Chromed / Cromo
-  Gold-plated / Oro

**Lampshade / Paralume**

**Material / Materiale** Fabric-PVC / Tessuto-PVC

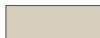
**Finishes / Finiture\***

-  Linen / Lino
-  Sand / Sabbia
-  Brown / Marrone
-  Bordeaux / Bordeaux

\*Other finishes available upon request / Altre finiture su richiesta

**NEW** | DOMINIQUE 15-30

Socket / Portalampada	B15d
Operating voltage / Voltaggio	12/24 V
Max power / Max potenza	20 W

Certifications / Certificazioni



Socket / Portalampada	E14
Operating voltage / Voltaggio	110/220 V
Max power / Max potenza	25 W

Certifications / Certificazioni



## Dimensions / Dimensioni

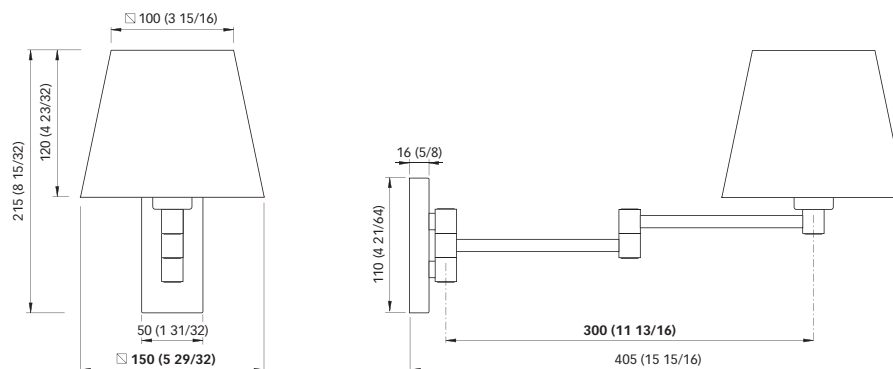

Dimensions in mm (inch)



**Articulated bracket / Braccio snodato**

**Material / Materiale** Brass / Ottone





**Finishes / Finiture**

-  Chromed / Cromo
-  Gold-plated / Oro

**Lampshade / Paralume**

**Material / Materiale** Fabric-PVC / Tessuto-PVC

**Finishes / Finiture\***

-  Linen / Lino
-  Sand / Sabbia
-  Brown / Marrone
-  Bordeaux / Bordeaux

\*Other finishes available upon request / Altre finiture su richiesta

**NEW | DOMINIQUE 18-30**

Socket / Portalampada	B15d
Operating voltage / Voltaggio	12/24 V
Max power / Max potenza	20 W

Certifications / Certificazioni



Socket / Portalampada	E14
Operating voltage / Voltaggio	110/220 V
Max power / Max potenza	25 W

Certifications / Certificazioni

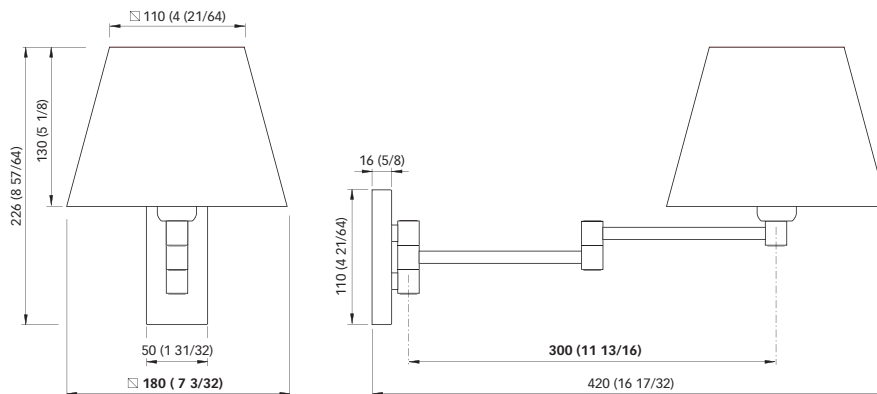
**Dimensions / Dimensioni**

Dimensions in mm (inch)



**Articulated bracket / Braccio snodato**

**Material / Materiale** Brass / Ottone





**Finishes / Finiture**

-  Chromed / Cromo
-  Gold-plated / Oro

**Lampshade / Paralume**

**Material / Materiale** Fabric-PVC / Tessuto-PVC

**Finishes / Finiture\***

-  Linen / Lino
-  Sand / Sabbia
-  Brown / Marrone
-  Bordeaux / Bordeaux

\*Other finishes available upon request / Altre finiture su richiesta

**NEW | DOMINIQUE 22-35**

Socket / Portalampada	B15d
Operating voltage / Voltaggio	12/24 V
Max power / Max potenza	20 W

Certifications / Certificazioni



Socket / Portalampada	E14
Operating voltage / Voltaggio	110/220 V
Max power / Max potenza	25 W

Certifications / Certificazioni

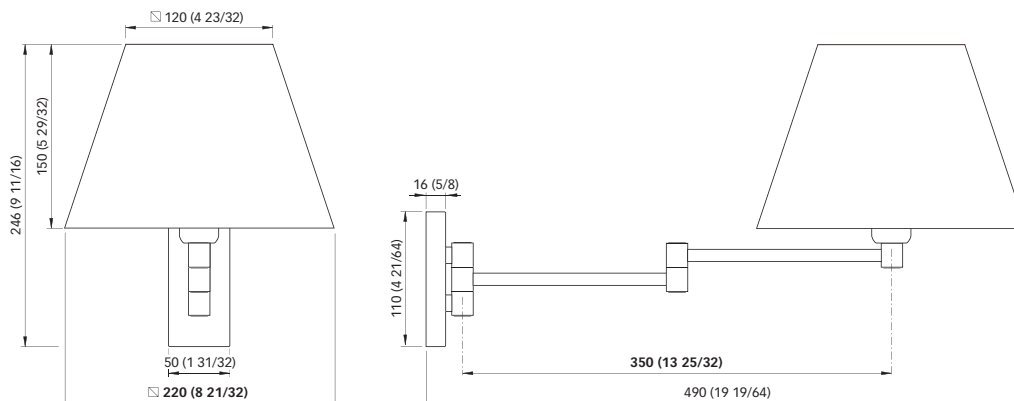
**Dimensions / Dimensioni**

Dimensions in mm (inch)





**Articulated bracket / Braccio snodato**

**Material / Materiale** Brass / Ottone





**Finishes / Finiture**

-  Chromed / Cromo
-  Gold-plated / Oro

**Lampshade / Paralume**

**Material / Materiale** Fabric-PVC / Tessuto-PVC

**Finishes / Finiture\***

-  Linen / Lino
-  Sand / Sabbia
-  Brown / Marrone
-  Bordeaux / Bordeaux

\*Other finishes available upon request / Altre finiture su richiesta

## TABLE LIGHTS WITH LAMP SHADE LAMPADRE DA TAVOLO CON PARALUME

**NEW ISOTTA 30-30**



p.250

Lampshade base Ø 300  
Articulated bracket 300  
Pole 310

**NEW DENISE 24-30**



p.252

Lampshade base side 240  
Articulated bracket 300  
Pole 330

**NEW SARAH**



p.254

Lampshade base side 150  
Fix bracket

Dimensions of diameter/maximum trim ring side length and recess are listed in mm  
Le dimensioni del diametro/lato max cornice e del recesso sono indicati in mm



QUICK MARINE LIGHTING

# TABLE LIGHTS WITH LAMPSHADE

FOR INTERIORS

TABLE LIGHTS WITH LAMPSHADE.  
SUPPORTS IN CHROMED BRASS.  
LAMPSHADES IN FABRIC COUPLED TO PVC.  
BULB WITH E14 AND B15d SOCKET.

LAMPADE DA TAVOLO CON PARALUME  
SUPPORTI IN OTTONE CROMATO.  
PARALUMI IN TESSUTO ACCOPPIATO A PVC.  
LAMPADINA CON ATTACCO E14 E B15d.

MODELS IN ALPHABETICAL ORDER

**NEW** | DENISE p. 252  
**NEW** | ISOTTA p. 250  
**NEW** | SARAH p. 254

**NEW | ISOTTA 30-30**

Socket / Portalampada	B15d
Operating voltage / Voltaggio	12/24 V
Max power / Max potenza	20 W

Certifications / Certificazioni



Socket / Portalampada	E14
Operating voltage / Voltaggio	110/220 V
Max power / Max potenza	25 W

Certifications / Certificazioni

**Dimensions / Dimensioni**

Dimensions in mm (inch)

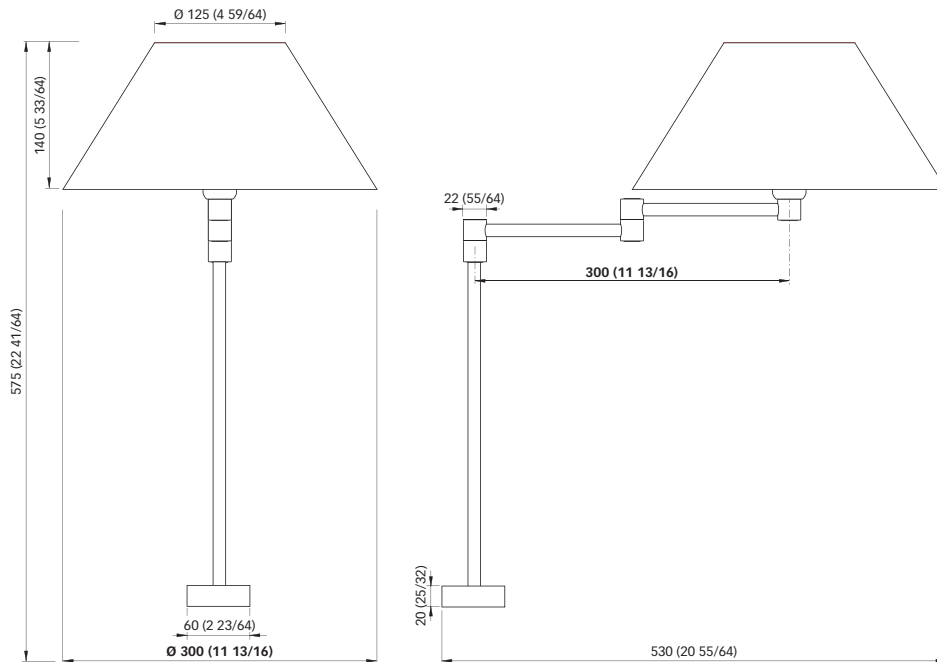

**NEW** | ISOTTA 30-30

**TABLE LIGHTS WITH LAMP SHADE  
LAMPADRE DA TAVOLO CON PARALUME**

15



**Articulated bracket / Braccio snodato**

**Material / Materiale** Brass / Ottone

**Finishes / Finiture**  Chromed / Cromo

 Gold-plated / Oro

**Lampshade / Paralume**

**Material / Materiale** Fabric-PVC / Tessuto-PVC

**Finishes / Finiture\***  Linen / Lino

 Sand / Sabbia

 Brown / Marrone

 Bordeaux / Bordeaux

\*Other finishes available upon request / Altre finiture su richiesta



**NEW | DENISE 24-30**

Socket / Portalampada	B15d
Operating voltage / Voltaggio	12/24 V
Max power / Max potenza	20 W

Certifications / Certificazioni



Socket / Portalampada	E14
Operating voltage / Voltaggio	110/220 V
Max power / Max potenza	25 W

Certifications / Certificazioni

**Dimensions / Dimensioni**

Dimensions in mm (inch)

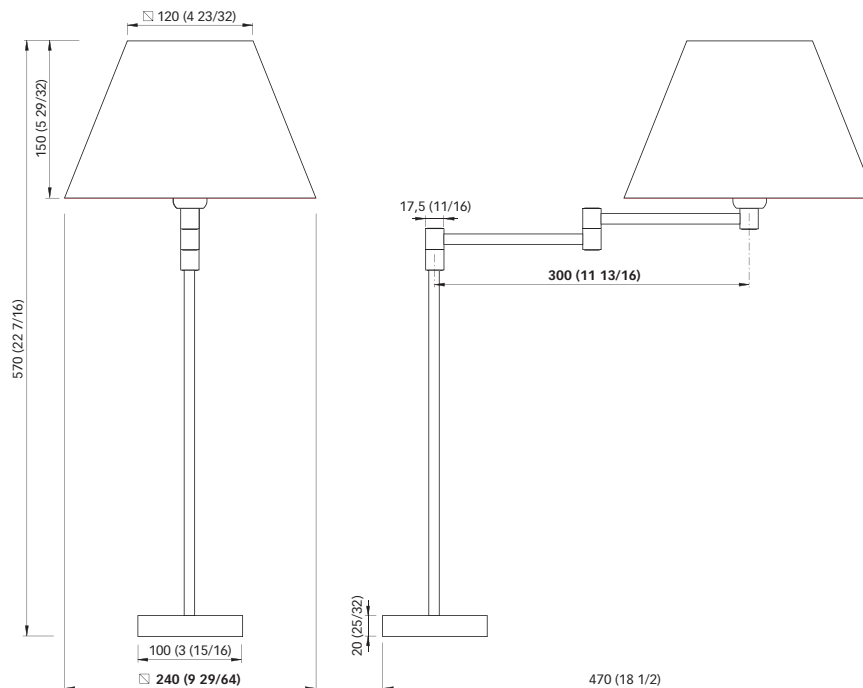

**NEW** | DENISE 24-30**TABLE LIGHTS WITH LAMP SHADE  
LAMPADRE DA TAVOLO CON PARALUME****Articulated bracket / Braccio snodato****Material / Materiale** Brass / Ottone**Finishes / Finiture**
 Chromed / Cromo

 Gold-plated / Oro
**Lampshade / Paralume****Material / Materiale** Fabric-PVC / Tessuto-PVC**Finishes / Finiture\***
 Linen / Lino

 Sand / Sabbia

 Brown / Marrone

 Bordeaux / Bordeaux

\*Other finishes available upon request / Altre finiture su richiesta

## SARAH

Socket / Portalampada	B15d
Operating voltage / Voltaggio	12/24 V
Max power / Max potenza	20 W

Certifications / Certificazioni



Socket / Portalampada	E14
Operating voltage / Voltaggio	110/220 V
Max power / Max potenza	25 W

Certifications / Certificazioni



## Dimensions / Dimensioni

Dimensions in mm (inch)

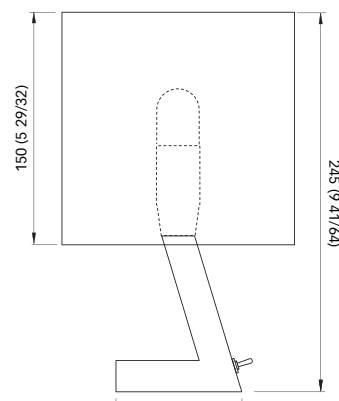
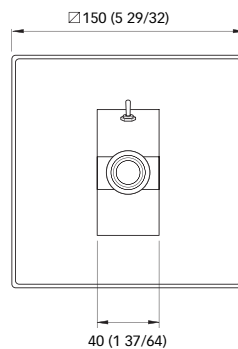

## SARAH

TABLE LIGHTS WITH LAMP SHADE  
LAMPADRE DA TAVOLO CON PARALUME**Material / Materiale**

Chromed alluminim  
Alluminio cromato







Opaque anodized aluminum  
Alluminio anodizzato opaco

**Lampshade / Paralume****Material / Materiale**

Fabric-PVC / Tessuto-PVC

**Finishes / Finiture\***

	Linen / Lino
	Sand / Sabbia
	Brown / Marrone
	Bordeaux / Bordeaux

\*Other finishes available upon request / Altre finiture su richiesta



**ACCESSORIES**

DIMMERS

16

POWER SUPPLIES

17

# DIMMERS

SPECIFIC DIMMERS FOR LED AND HALOGEN DOWNLIGHTS  
DIMMERS SPECIFICI PER FARETTI A LED E ALOGENI

15

IP20



<b>Model</b> <b>Modello</b>	<b>LDM1</b>
Input voltage Tensione in ingresso	10 - 30 Vdc
Capacity Capacità	Up to 100 spot with Power LED Fino a 100 spot con Power LED
No. of controls No. Comandi	Unlimited (wired in parallel) Illimitato (cablati in parallelo)
Command type Tipo comando	Push Button Pulsante
Compatibility Compatibilità	Luminaires with dimming input Apparecchi d'illuminazione con ingresso dimmerazione
Dimensions / Dimensioni	65 X 37 X 21 mm 2 4/16 X 1 29/64 X 53/64 in

## Compatibility models / Compatibilità modelli

CHIARA	Power LED downlight
DEMETRA	Power LED downlight
KAI	Power LED downlight
KOR	Power LED downlight
KRISTINE	Power LED downlight
MARINA	Power LED downlight
NIKITA	Power LED downlight
SONIA	Power LED downlight
VANESSA	Power LED downlight

Certifications / Certificazioni



## ZDIM100

LED DIMMING MODULE  
MODULO DIMMER PER LED

IP20



<b>Model</b> <b>Modello</b>	<b>ZDIM100</b>
Input voltage Tensione in ingresso	12 - 24 Vdc
Max Load Max Carico	50 W @ 12 V - 100 W @ 24 V
Command type Tipo comando	Push Button Pulsante
Fuse Fusibile	8 A
Compatibility Compatibilità	All downlights with Zelig SE or BE installed Tutti i faretti con Zelig SE o BE installati
Dimensions / Dimensioni	80 X 30 X 56 mm

Certifications / Certificazioni



## Compatibility models / Compatibilità modelli

BRYAN	LED downlight
EDWIN	LED downlight
LUCILLE	LED downlight
MINDY	LED downlight
MINDY S	LED downlight
MIRIAM	LED downlight
OLIVER	LED downlight
OLIVER S	LED downlight
OMAR	LED downlight
SANDY	LED downlight
SELENE	LED downlight
TED	LED downlight
TIM	LED downlight
TIM S	LED downlight
YOKO	LED downlight
ZELIG SE	LED Side Entry
ZELIG BE	LED Back Entry



## HDIM300

## DC DC DIMMER MASTER/SLAVE

16



IP20

Model Modello	HDIM300 MASTER	HDIM300 SLAVE
Input voltage Tensione in ingresso	12 - 24 Vdc	
Max Load Max Carico	150 W @ 12 V DV / 300 W @ 24 V DC	
Command type Tipo comando	Push Button Pulsante	Signal from HDIM300 MASTER Segnale proveniente da HDIM300 MASTER
Installation Installazione	DIN EN 50.022 Bar Barra DIN EN 50.022	
Power Fuse Fusibile	15 A	
Compatibility Compatibilità	All kind of halogen and incandescent lamps Tutti i tipi di lampadine alogene e a incandescenza	
Dimensions / Dimensioni	52 X 88 X 58 mm 2 3/64 X 3 29/64 X 2 49/64 in	

Certifications / Certificazioni



Compatibility models / Compatibilità modelli

ALEX	Halogen downlight
ANDREAS	Halogen downlight
BORIS	Halogen downlight
CARMEN	Halogen downlight
EDGAR	Halogen downlight
ELISABETH	Halogen downlight
GIULIA	Halogen downlight
LARA	Halogen downlight
LISA	Halogen downlight
LAWRENCE	Halogen downlight
LUCREZIA	Halogen downlight
MINA	Halogen downlight
OLAF	Halogen downlight
OSCAR	Halogen downlight
SABINE	Halogen downlight
SHARON	Wall light
SHEILA	Wall light
SILVIA	Halogen downlight
STRIP LED	LED indirect light
TEO	Halogen downlight
TOM	Halogen downlight
TOSCA	Halogen downlight
XYPHER	LED underwater



# POWER SUPPLIES







POWER SUPPLIES AC-DC  
ALIMENTATORI AC-DC

17

## PS 45/60/240

## POWER SUPPLIES AC-DC ALIMENTATORI AC-DC

IP20

Model Modello			
	PS45*	PS60	PS240*
Input voltage Tensione in ingresso	85 - 264 Vac 50/60 Hz		
Output voltage Tensione in uscita	24 Vdc		
Max Load Max Carico	45 W	60 W	240 W
Load max Ampere Max Ampere sul carico	2 A	2,5 A	10 A
Protections Protezioni	Overheating - Overvoltage - Overload Surriscaldamento - Sovratensione - Sovraccarico		
Installation Installazione	DIN EN 50.022 Bar Barra DIN EN 50.022		
Dimensions Dimensioni	93 X 78 X 67 mm 3 21/32 X 3 1/16 X 2 41/64 in	78 X 93 X 56 mm 3 1/16 X 3 21/32 X 2 13/64 in	125 X 125 X 100 4 59/64 X 4 59/64 X 3 15/16 in
Class Classe			

Certifications / Certificazioni

**TUV UL CUL CB CE**

\*PS45 and PS240 models are available only upon request

\*I modelli PS45 e PS240 sono disponibili solo su richiesta

## Spare bulbs suitable for Quick Marine Lighting products

Lampadine di ricambio adatte ai prodotti Quick Marine Lighting

Model	LED		Halogen XENON			Incandescent Bulb	
	ZELIG Side Entry (1)	ZELIG Back Entry (1)	G4 (1)		G9	B15d	E14
			Max 10 W	Max 20 W	Max 20 W	Max 20 W	Max 25 W
ALEX				●			
ANDREAS		●		●			
BERNARD (2)	●		●				
BORIS				●			
CARMEN				●	●		
EDGAR (2)	●		●				
ELISABETH				●			
GIULIA				●			
LARA				●			
LAWRENCE		●		●			
LISA				●			
LUCREZIA				●			
MILLY (2)	●						
MINA (2)	●		●				
OLAF (2)	●		●				
OSCAR (2)	●		●				
SABINE (2)	●		●				
SALLY (2)	●						
SHARON						●	●
SHEILA						●	●
SILVIA				●			
TEO (2)	●		●				
TOM (2)	●		●				
TOSCA				●	●		

(1) Quick Marine Lighting product available

(2) **Bernard, Edgar, Mina, Milly, Olaf, Oscar, Sabine, Sally, Teo, Tom, Andreas and Lawrence downlights** can be converted to LED. In order to insert Zelig LED, the reflector conceived for the halogen bulb shall be removed.

(1) Prodotto Quick Marine Lighting disponibile

(2) I faretti **Bernard, Edgar, Mina, Milly, Olaf, Oscar, Sabine, Sally, Teo, Tom, Andreas e Lawrence** sono convertibili a LED. Per inserire Zelig LED occorre rimuovere la parabola predisposta per la lampadina alogena.





**Quick Srl**

via Piangipane 120/a - 48124 Piangipane (RA) Italy

Tel +39 0544 415061 - Fax +39 0544 415047

[quick@quickitaly.com](mailto:quick@quickitaly.com)

[www.quickmarinelighting.com](http://www.quickmarinelighting.com)

[www.quickitaly.com](http://www.quickitaly.com)

# MARINE